

LED PROJECTOR USER INSTRUCTIONS

1/ Recommendations:

- It must be installed by a qualified electrician.
- Cut the mains power supply before any interventions.
- Do not use a damaged product.
- Read the instructions carefully before any intervention.
- Replace all cracked protective screens.
- Make sure you respect a minimum distance of 1m between the projector and any lit object.

2/ Specifications:

- Voltage: 85 - 265V~ 50/60Hz
- Power: 10W – 20W – 30W – 50W.
- Operating temperature: -40°C to +55°C
- Operating relative humidity: ≥ 90%
- Detection angle: 120°
- Detection distance: 8 to 12m
- Surrounding brightness: 5 to 1000Lux
- Lighting duration: from 15 sec. to 8 min. approx.
- Protection index: IP65 - Protection from dust and sprayed water.
- Protection class for electric shocks: Class 1.

3/ Installation :

Warning: Cut the mains power supply.

- 1 - Unscrew the 2 projector support screws and remove the projector (diagram 1).
- 2 - Place the projector in the required location and mark the fixture holes on the wall (diagram 2). Make sure the projector is placed in a way that makes the wiring easy.
- 3 - Drill the wall using a drill and insert the appropriate plugs (diagram 3). Recommended drilling diameter: min. 6mm
- 4 - Position the support and screw it using the appropriate screws and washers if necessary (diagram 3).
- 5 - Unscrew the 4 screws on the connecting box at the back of the projector (diagram 4) and then remove the cover.
- 6 - Connect the projector to the electricity supply making sure to pass the cable through the cable gland. (diagram 5) Recommended cable: H05RN-F or H07RN-F 3G1mm².
- 7 - Then close the connecting box and refit the 4 screws, making sure to refit the watertight seal correctly.
- 8 - Tighten the counter nut on the cable gland to give optimum water tightness around the passage of the cable.
- 9 - Then fix the projector onto its support and refit the 2 fixture screws (diagram 6). If the projector is fitted with a movement sensor, it must be below the projector and the settings buttons must be towards the bottom.

4/ Settings (For projectors fitted with a movement sensor):

- 1 - Orient the movement sensor in the required direction (diagram 7).
- 2 - Adjust the sensor according to the type of operation required using the 3 settings buttons (diagram 8).

"DIRECTION" BUTTON = Sensor sensitivity settings. Turn the button towards the "+" to increase sensitivity. Turn it towards the "-" to reduce sensitivity.

"TIME" BUTTON = Sets the projector lighting time after the detection of a movement in the detection field. Turn the button towards the "+" to increase the time. Turn the button towards the "-" to reduce the time.

"LUX" BUTTON = Sets the brightness threshold for detection. Set the button on the "sun" to operate both during the day and at night. Set the button on the "moon" to operate only at night. Then adjust the settings using the button and carrying out detection tests to find the required brightness level.

5/ Troubleshooting:

- The passage of motorised machinery close by can trigger projectors fitted with a sensor unexpectedly.
- Surrounding trees and shrubs, falling leaves and gusts of wind can trigger the projector unexpectedly.
- A projector located under a roof or beneath trees is likely to light during the day due to lack of brightness.
- If the projector does not work, check the lamp and the electric circuit.

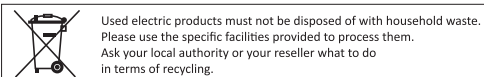
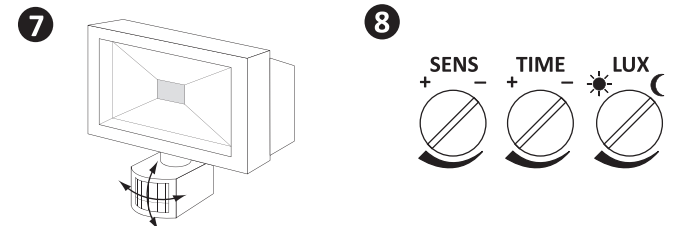
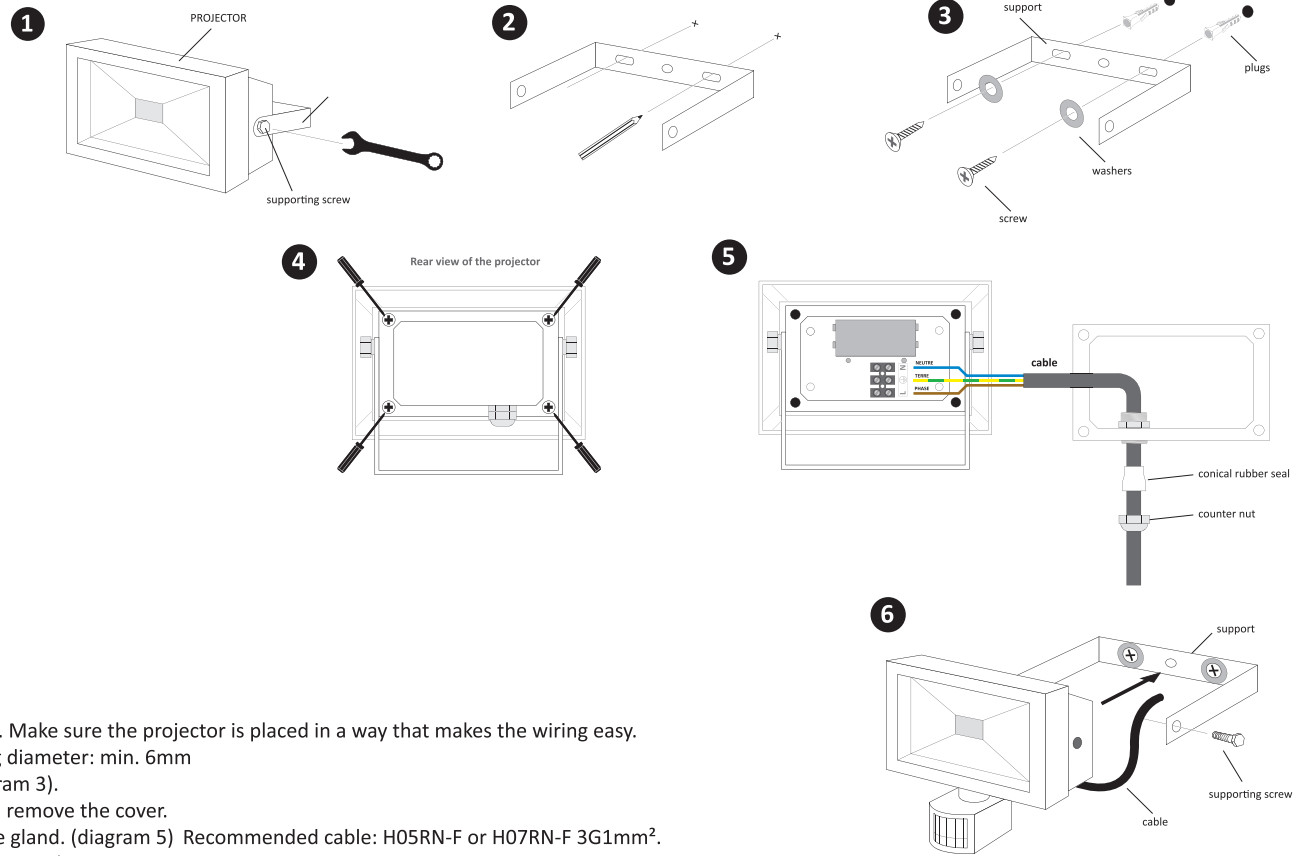

Minimum distance from the lit object = 1m



Replace all cracked protective screens.

Gyártó/ Producer:

Daniella Ker. Kft.
H-4031, Debrecen, Köntösgát sor 1-3
www.daniella.hu

HASZNÁLATI ÚTMUTATÓ LED REFLEKTORHOZ

1, Javaslatok:

A szerelést csak villamos szakember végezheti!
Felszerelés előtt a hálózati feszültséget kapcsolja le!
Sérült, selejtes terméket ne használjon!
A használati útmutatót minden felszerelés előtt olvassa el!
Törött üvegburkolatot cserélje ki!
Győződjön meg róla, hogy a reflektor és a megvilágított test között legalább 1 m távolságot tartson!

2, Jellemzők:

Névleges feszültség: 85-265V 50/60Hz
Névleges teljesítmény: 10W-20W-30W-50W
Működési hőmérséklet: -40°C és +55°C között
Relatív páratartalom: ≥ 90%
Érzékelési szög: 120°
Érzékelési távolság: 8 és 12m között
Környezeti megvilágítás: 5 és 1000Lux között
Világítási időtartam: Kb. 15 másodperc 8 perc
IP védettség: IP65 - Por és fröccsenő víz ellen védett
Érintésvédelmi kategória: I.

3, Felszerelés:

- 1, Csavarja ki a két tartócsavart és távolítsa el a reflektort a felfogató fülről. (1-es ábra)
 - 2, Helyezze el a felfogató fület a megfelelő helyre és jelölje be a lyukakat a falon (2-es ábra). Győződjön meg róla, hogy a felhelyezés során a vezetékélés könnyen megvalósítható legyen.
 - 3, Fúrja ki a lyukakat a falon és helyezze be a tipliket. (3-as ábra). Ajánlott átmérő: min. 6mm.
 - 4, Helyezze fel a felfogató fület és csavarja be a falba, szükség esetén használjon alátétet (3-as ábra).
 - 5, Csavarja ki a 4 csavart a kapcsolódoboz hátuljából és távolítsa el a fedelet (4-es ábra).
 - 6, Csatlakoztassa a vezetékeket a sorkapcsokhoz. Győződjön meg róla, hogy a vezetékek át vannak fűzve a tömszelence bemeneten (5-ös ábra). Ajánlott vezetékek: H05RN-F vagy H07RN-F 3G1mm2
 - 7, Helyezze vissza a kapcsolódoboz fedelét és csavarja be a 4 csavart. Győződjön meg róla, hogy a tömítések megfelelően vannak elhelyezve.
 - 8, Szorítsa meg a tömszelence anyát, hogy megfelelően tömítsen a vezeték bemenet körül.
 - 9, Helyezze el a reflektort a felfogatófültre, csavarja vissza a 2 rögzítőcsavart (6-os ábra).
- Mozgásérzékelős reflektor esetén a mozgásérzékelőknek a reflektor alatt kell elhelyezkedniük és az állító gomboknak lefelé kell nézniük.

4, Beállítások (mozgásérzékelős reflektorok esetén)

- 1, Állítsa be a mozgásérzékelőt a kívánt irányba (7-es ábra)
 - 2, Állítsa be a mozgásérzékelőt a kívánalmaknak megfelelően a három beállító gomb segítségével! (8-as ábra).
- IRÁNY/ DIRECTION gomb = Érzékenység beállítása. A + jel felé forgatással növelheti az érzékenységet. A – gomb felé csökkentheti az érzékenységet.
IDŐ/TIME gomb = Beállíthatja a reflektor világítási időtartamát az érzékelés után. A + felé forgatással növelheti, a – jel felé csökkentheti az időtartamot.
FÉNYERŐ/LUX gomb = Beállíthatja az érzékelési fényerőt. A nap jel felé állítással nappal és éjszaka is működik a reflektor, a hold jel felé állítással csak éjszaka működik.
A gomb állításával kikapaszthatja, hogy milyen fényviszonyok között szeretné működtetni a reflektort.

5, Hibaelhárítás

Motorizált járművek elhaladása a reflektor előtt váratlan működést eredményezhetnek.
Környező fák, bokrok, hulló falevelek, szélökökésék váratlan működést eredményezhetnek.
Tető vagy fa alá helyezett reflektor működése az alacsony fényviszonyok miatt elmaradhat az elvárttól.
Ha a reflektor nem működik, ellenőrizze a készüléket és a hálózatot.

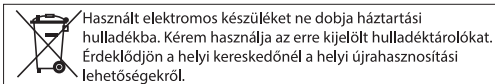
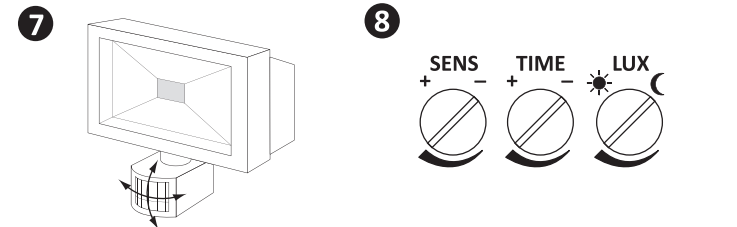
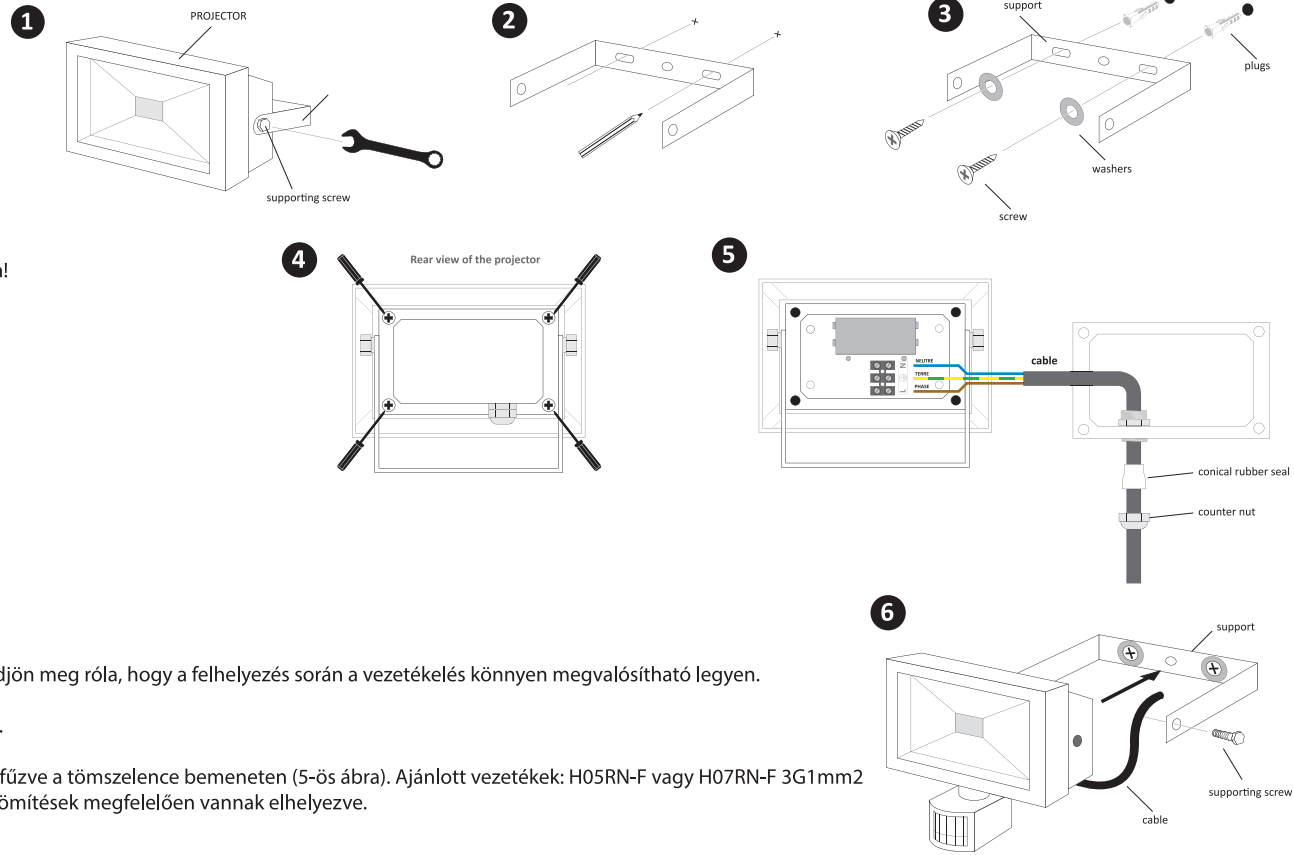

Gyártó/ Producer:

Daniella Ker. Kft.
H-4031, Debrecen, Köntösgát sor 1-3
www.daniella.hu

MANUAL DE UTILIZARE PENTRU REFLECTOR LED

1.Recomandări:

Instalarea poate fi efectuată numai de un tehnician calificat!

Oprii alimentarea de curent înainte de instalare!

Nu folosiți produse stricate/avariate!

Citiți instrucțiunile de utilizare înainte de instalare!

Înlocuiți capacul din sticlă dacă este spartă!

Păstrați o distanță de cel puțin 1 m între reflector și suprafața/corpus iluminat!

2.Characteristici:

Tensiunea nominală: 85-265V 50/60Hz

Putere nominală: 10W-20W-30W-50W

Temperatura de funcționare: -40°C - +55°C

Umiditate relativă: ≥ 90%

Unghi de detecție: 120°

Distanță de detecție: 8 - 12m

Lumină ambientală: 5 - 1000Lux

Durata de iluminare: 15 sec 8 min

Protecție IP: IP65

Categorie protecție la atingere: I.

3.Instalare:

1.Desfaceți cele două șuruburi de fixare și îndepărtați reflectorul de pe fila de montare.(Figura 1)

2. Se pune fila de montare la locul potrivit și se marchează peretele prin orificiile filei de montare (Figura 2). În timpul instalării asigurați-vă că, cablarea poate fi realizată ușor.

Găuriți peretele în locurile marcate și introduceți diblurile. (Figura 3). Diametrele recomandate: min. 6mm.

4 Atașați fila de montare și fixați în perete, folosiți o șaibă dacă este necesar.(Figura 3)

5.Desfaceți cele patru șuruburi de pe partea din spate a cutiei de comutare și scoateți capacul (Figura 4).

6.Conectați cablurile la clemele de legătură.. Asigurați-vă că firele sunt trecute prin presetupe (Figura 5). Cabluri recomandate: H05RN-F sau H07RN-F 3G1mm2

7.Puneți la loc capacul cutiei de comutare și închideți cu șuruburi. Asigurați-vă că garniturile sunt poziționate corect.

8. Strângeți piulița presetupei pentru a sigila în mod corespunzător în jurul cablului de intrare.

9.Așezați reflectorul pe fila de montare și fixați cu cele două șuruburi.(Figura 6)

În caz de reflectoare cu senzor de mișcare, senzorul de mișcare trebuie poziționat sub reflector, iar butoanele de ajustare trebuie orientate în jos.

4.Setări (pentru reflectoare cu senzor de mișcare)

1. Ajustați senzorul de mișcare în direcția dorită (Figura 7)

2. Se reglează senzorul de mișcare în funcție de cerințe cu cele trei butoane de ajustare! (Figura 8).

Buton DIRECTIE / DIRECTION = Reglare sensibilitate. Rotiți spre semnul + pentru a mării, spre semnul - pentru a scădea sensibilitatea!

Buton TIMP / TIME= setarea duratei de iluminare după detectarea. Rotiți spre semnul + pentru a mării, spre semnul - pentru a scădea durata de iluminare.

Buton LUMINOZITATE/LUX=setarea luminozității de detecție.Rotind spre semnul „soare” senzorul de mișcare va funcționa în timpul zilei și în timpul nopții,

rotind spre semnul „lună” senzorul de mișcare va funcționa numai în timpul nopții.Prin ajustarea butonului puteți afla ca în ce condiții de luminozitate doriți să funcționeze senzorul de mișcare.

5.Depanarea

Trecerea vehiculelor motorizate în fața reflectorului, poate cauza funcționare neașteptată a reflectorului.

Copaci din jur, arbuști, frunze căzute, rafalele de vânt pot cauza funcționare neașteptată.

Funcționarea reflectorului amplasat sub un acoperiș sau copac, poate să difere/scadă față de cel așteptat.

În cazul în care reflectorul nu funcționează, verificați dispozitivul și rețea.

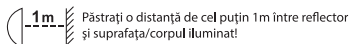
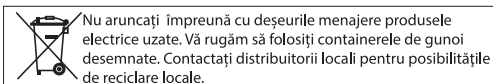
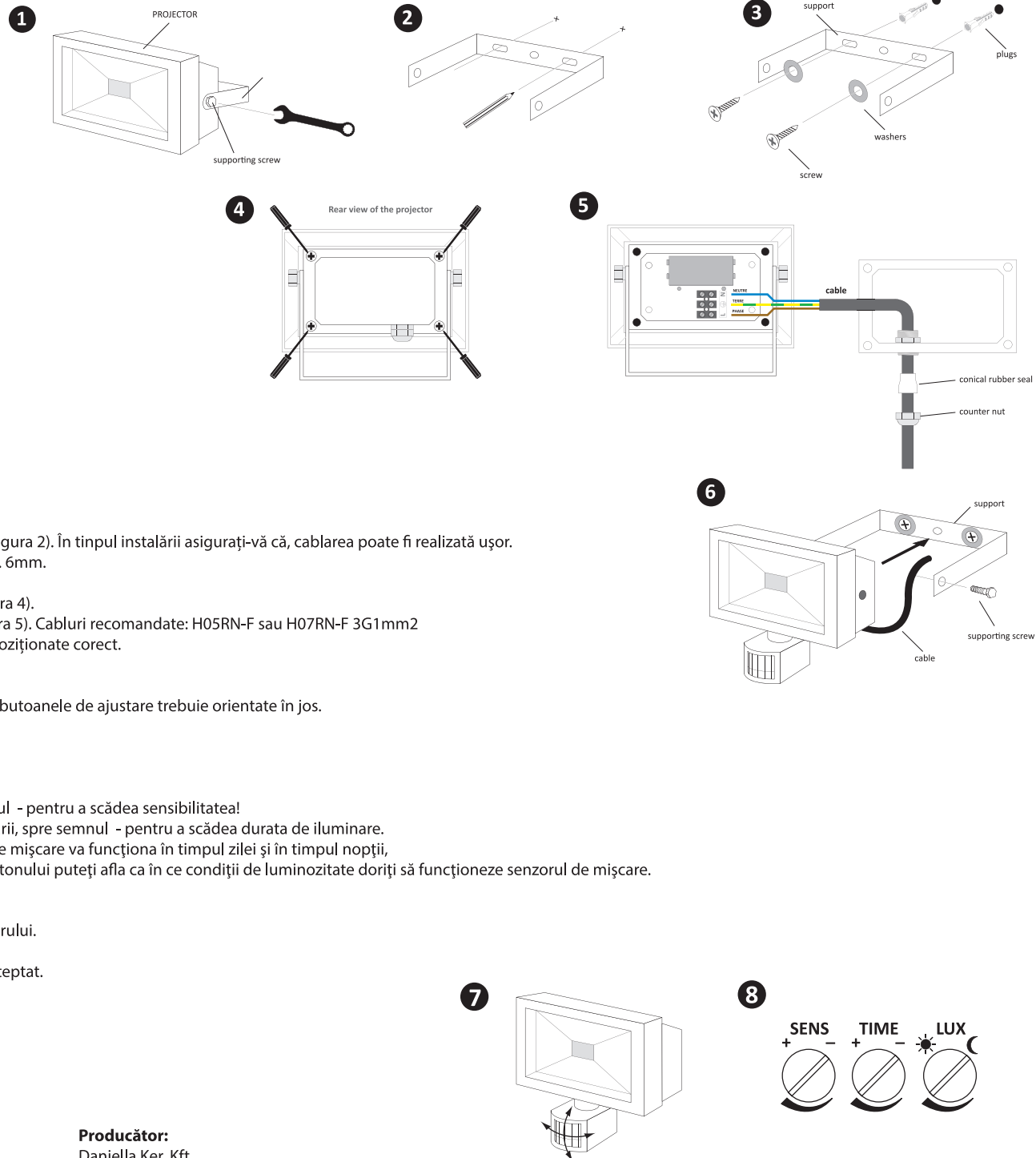

Producător:

Daniella Ker. Kft.

H-4031, Debrecen, Köntösgát sor 1-3

www.daniella.hu

INSTALLATION MANUAL

RGB FLOODLIGHT



100-240V | IP65 | Die cast | Adjustable
Complete with remote control and LED driver

- a. Colour change
- b. Dim Brightness level up/down
- c. Turn on/off
- d. Flash -Six colours frequent hopping change
Strobe -Six colours slow hopping change
Fade -Six colours frequent gradual change
Smooth-Six colours slow gradual change

INTRODUCTION

This LED Lighting fixture consists of a high power LED, which is environmentally friendly, energy-saving and the best solution for replacement of conventional Lighting.

CONSTRUCTION

Extruded aluminium housing, 4mm toughened glass, high-quality PMMA lens, universal voltage input 100-240V, IP65 water resistant.

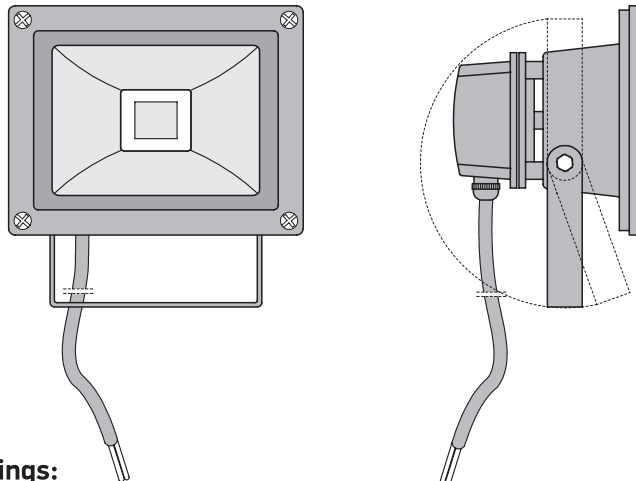
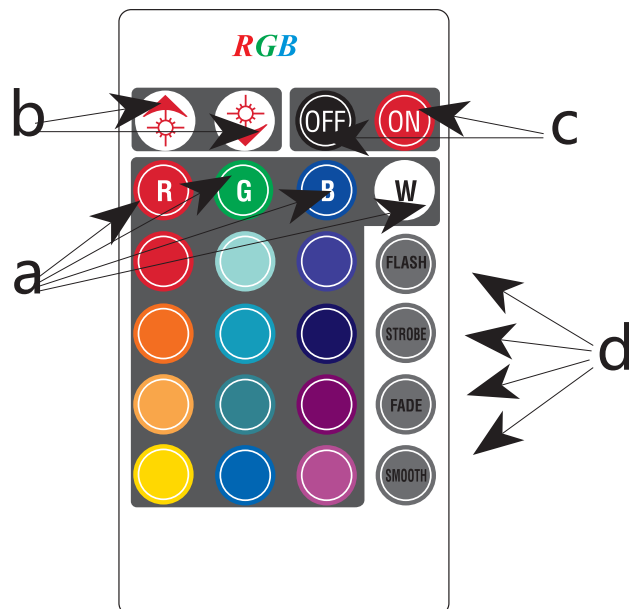

Warnings:

1. Make sure that the product is installed properly before connecting to electricity.
2. Do not cover the fitting.
3. Maintenance and installation should only be carried out by a professional electrician.

KIEGÉSZÍTŐ ÚTMUTATÓ RGB LED REFLEKTORHOZ



100-240V | IP65 | ÖNTÖTT | ÁLLÍTHATÓ
A termék rendelkezik távirányítóval.

BEVEZETŐ

Ez a LED reflektor nagy teljesítményű LEDdel rendelkezik, ami környezetbarát, energiatakarékos és a hagyományos világítás legjobb helyettesítésére szolgál.

FELÉPÍTÉSE

Extrudált alumínium ház, 4mm vastag üveg búra, magas minőségű PMMA lencsék, univerzális feszültség bemenet 100-240V, IP65 védelemben.

- a, szín változtatása
- b, fényerősség fel/le változtatása
- c, be-/ kikapcsolás
- d, FLASH/ villogó – 6 szín gyakori színváltozása
- STROBE/ stroboszkóp – 6 szín lassú színváltozása
- FADE/ Halványulás – 6 szín gyakori fokozatos színváltozása
- SMOOTH/ Egyenletes – 6 szín lassú fokozatos színváltozása

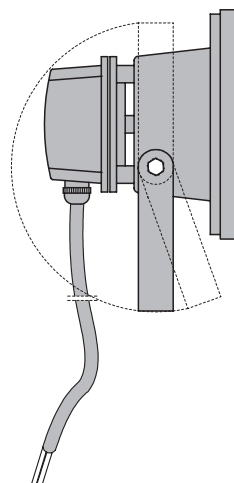
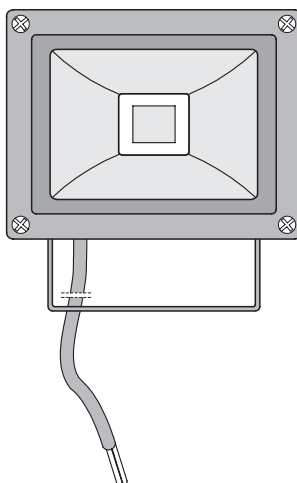
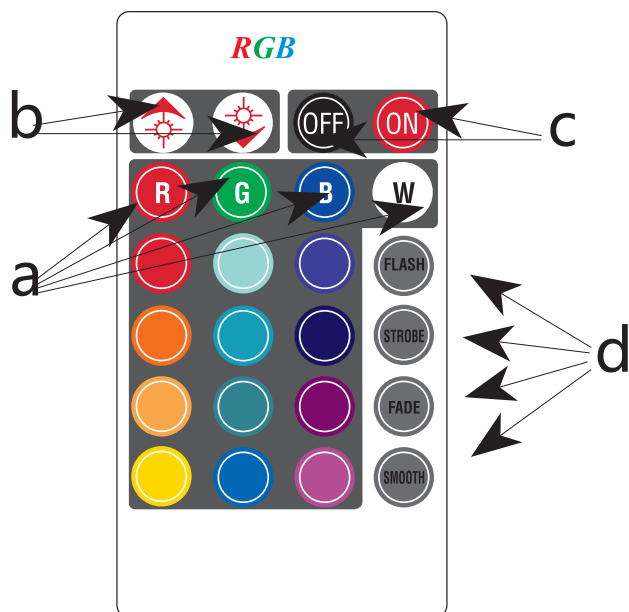

INSTRUCȚIUNI DE UTILIZARE PENTRU REFLECTOR LED RGB



100-240V | IP65 | DIE CAST | ADJUSTABLE
 PRODUSUL ARE TELECOMANDĂ.

a, schimbarea culorii
 b, schimbarea intensității luminii sus/jos
 c, pornire/oprire
 d, FLASH / intermitent -6 culori schimbate frecvent
 STROBE / stroboscop – 6 culori schimbate lent
 FADE / decolorare - 6 culori schimbate treptat frecvent
 SMOOTH/neted - 6 culori schimbate lent/treptat

INTRODUCERE

Acest reflector cu LED este dotat cu LED-uri de înaltă performanță, ecologice, energetic eficiente, și care sunt cei mai buni înlocuitori ai iluminării tradiționale!

STRUCTURĂ

Carcasă din aluminiu extrudat, abajur de sticlă de 4 mm grosime, lentile PMMA de înaltă calitate, tensiunea de intrare universală 100-240V, grad de protecție IP65.

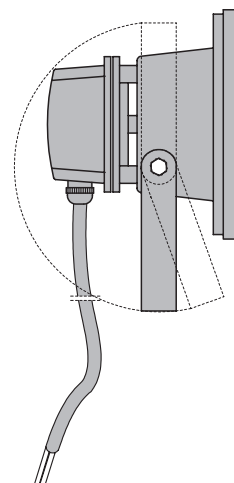
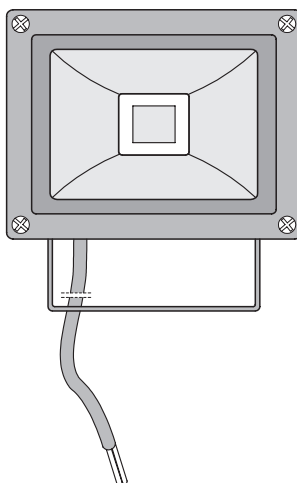
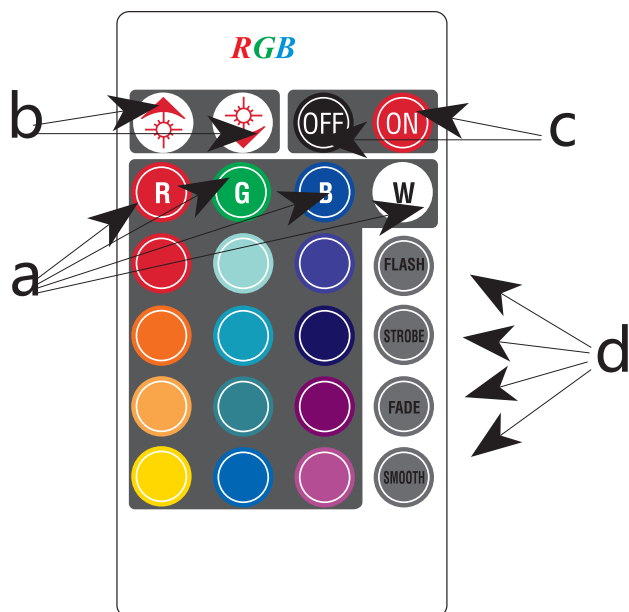

USER MANUAL

LED RECHARGEABLE FLOODLIGHT

10W



Car charger



AC adapter



- 1, Handle
- 2, Fix screw
- 3, U-shape bracket
- 4, Stand bracket
- 5, Power switch
- 6, Charging port
- 7, Stand bracket fix screw

Note:

LED indicator

Charging: LED indicator is red

Fully charged: LED indicator turns to green

All the lamps are fully charged before delivery.
 Please use the chargers equipped with the lamp!
 Please do not turn on the light when charging!
 Please do not use modified or damaged charger!
 Please do not charge the lamp over 24 hours!
 Please do not disassemble the lamp!
 Please recharge the lamp in every six months, when in stock!

Warning!

This device utilizes a rechargeable lithium-ion battery, that can rupture, ignite, and cause serious injury, if being used improperly.

Please check the following safety rules:

DO NOT place batteries and devices in the fire or high temperature!

DO NOT tamper with battery wiring!

DO NOT puncture or damage the batteries!

DO NOT use the batteries, that appear damaged!

DO NOT expose or immerse the batteries to the water!

DO NOT alter or modify the batteries!

DO NOT attempt changing the batteries in any matter other than that prescribed in this manual!

DO NOT dispose of the battery in the fire or water!

Fail to heed the warning may result in personal injury or property damage.

KIEGÉSZÍTŐ ÚTMUTATÓ HORDOZHATÓ LED REFLEKTORHOZ 10W



Töltő szivargyújtóhoz



Hálózati töltő



10W



- 1, Fogantyú
- 2, Rögzítő csavar
- 3, U alakú tartó
- 4, Állvány
- 5, Kapcsoló
- 6, Töltő csatlakozó
- 7, Állvány rögzítő csavar

Figyelmeztetés!

LED kijelző:

Töltés: LED kijelző pirosan világít

Teljes feltöltött állapot: LED kijelző zölden világít

Csak a gyári töltőket használja töltéshez!
Ne kapcsolja be a reflektort töltés közben!
Ne használjon sérült vagy átalakított töltőt!
Ne töltsa a lámpát 24 óránál hosszabb ideig!
Ne szerelje szét a lámpát!

Ez a termék újratölthető lithium-ion akkumulátort tartalmaz, ami eltörhet, tüzet és súlyos sérülést okozhat nem rendeltetésszerű használat esetén.
Ne tegye tűzbe vagy magas hőmérsékletre!
Ne kössön az akkumulátorhoz vezetékét!
Ne ütögesse vagy rongálja az akkumulátort!
Ne használjon sérült akkumulátort!
Ne merítse az akkumulátort vízbe!
Ne változtasson az akkumulátoron!
Ne próbálja meg másra használni az akkumulátort, mint a jelenlegi használati útmutatóban előírtak.
Ne dobja az akkumulátort tűzbe vagy vízbe!
Jelen figyelmeztetések figyelmen kívül hagyása személyi sérülést vagy anyagi kárt okozhat!

MANUAL DE UTILIZARE PENTRU REFLECTOR CU LED PORTABIL 10W



Car charger



AC adapter

10W

Utilizați numai încărcătoare din fabrică pentru încărcare!
Nu porniți reflectorul în timpul încărcării!
Nu utilizați un încărcător deteriorat sau modificat!
Nu încărcați mai mult de 24 de ore!
Nu demontați lampa!

Acest produs conține o baterie reîncărcabilă litiu-ion, care se poate deteriora, cauzând foc sau rănire gravă a unei persoane în cazul utilizării necorespunzătoare.
Evitați contactul cu foc sau temperaturi ridicate!
Nu conectați cabluri la baterie!
Nu loviți sau deteriorați bateria!
Nu utilizați baterii deteriorate!
Nu scufundați bateria în apă!
Nu schimbați bateria!
Nu încercați să folosiți bateria pentru nimic altceva decât decât la cele descrise în instrucțiunile actuale de utilizare furnizate.
Nu aruncați niciodată bateriile în foc sau apă!
Ignorarea avertismentelor poate duce la vătămări corporale sau pagube materiale!



1. Mâner
2. Șurub de fixare
3. Suport în formă de U
4. Stand
5. Întrerupător
6. Conector încărcător de baterie
7. Șurub de fixare stand

Atenție!

Afișaj cu LED-uri:

Încărcare: indicator LED este roșu

Complet încărcat: indicatorul LED este verde