

- For use in Ex zones 1 and 2 (gases, vapours, mists) as well as Ex zones 21 and 22 (dusts)
- Tested according to explosion group IIB
- Time-saving installation – no need to deactivate systems/areas for welding or drilling work



EX BRS 500 (540 805)

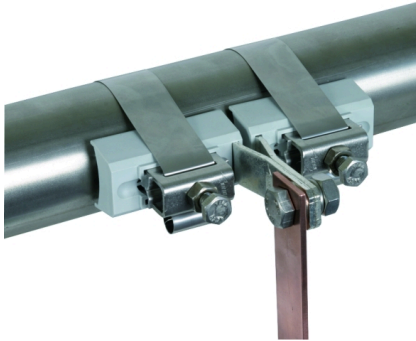
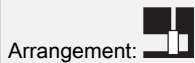
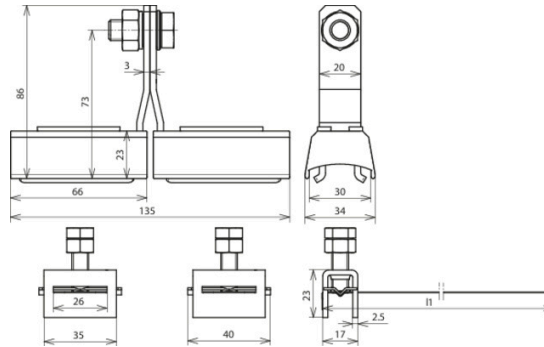

Figure without obligation



Arrangement:

Type	EX BRS 500
Part No.	540 805
Lightning impulse current (10/350 µs) St/bare (I_{imp})	50 kA
Lightning impulse current (10/350 µs) StSt (I_{imp})	50 kA
Class of lightning current carrying capability acc. to EN 62561-1	N
Connection	M10
Clamping range pipe Ø	300-500 mm
Material of clamp body	polyamide
Material of grip head / tensioning strap	StSt
Material of contact piece	Cu/gal Sn
Dimensions of tensioning strap (l1 x w x d)	1850 x 25 x 0.3 mm
Design	UV stabilised
Standard	EN 62561-1
Weight	766 g
Customs tariff number (Comb. Nomenclature EU)	85359000
GTIN	4013364128873
PU	1 pc(s)

We reserve the right to introduce changes in performance, configuration and technology, dimensions, weights and materials in the course of technical progress. The figures are shown without obligation.

With regard to corrosion resistance, it must be checked whether the materials used for the Ex pipe clamps, Ex BRS ... (e.g. Cu/galSn, brass/galSn, StSt, polyamide) can be used in the existing ambient conditions.