

DX³ MCB 25kA up to 63A (1,5 modules per pole)

Cat N°(s): 4 097 20 to 4 098 95



CONTENTS	PAGES
1. Description - use	1
2. Range	1
3. Overall dimensions	1
4. Preparation - Connection	1
5. General characteristics	2
6. Conformities and approvals	20
7. Characteristic curves	21
8. Auxiliaries and accessories	38

1. DESCRIPTION - USE

Thermo-magnetic circuit breaker with positive contact indication for control, protection and isolation of electrical circuits.

Symbol:



Technology:

- . Current limiting device.
- . 1,5 module (26,7 mm) per pole.
- . Trip free mechanism.

2. RANGE

Number of Poles:

- . 1P / 2P / 3P / 4P.

Rated current In:

- . 32 / 40 / 50 / 63 B and C curves.
- . 16 / 20 / 25 / 32 / 40 / 50 / 63 D curve.
- . 12,5 / 16 / 25 / 40 / 63 MA curve.

Tripping characteristics and magnetic tripping calibrations:

- . B curve (between 3 and 5 In).
- . C curve (between 5 and 10 In).
- . D curve (between 10 and 14 In).
- . MA curve (between 12 and 14 In, with tolerances reduced to + / -10%).

Thermal threshold:

- . Non operating current (Inf): 1,05 In.
- . Operating current (If): 1,3 In.

Rated Voltage / Frequency:

- . 230 / 400 V ~, 50 / 60 Hz with standard tolerances.
- . 240 / 415 V ~, 50 / 60 Hz with standard tolerances.
- . 125 V per pole in direct current.

Maximum operating voltage:

- . 500 V ~, 50 / 60 Hz with derating of breaking capacity.

Breaking capacity:

- . 25 kA according to IEC/EN/NF 60947-2

3. OVERALL DIMENSIONS

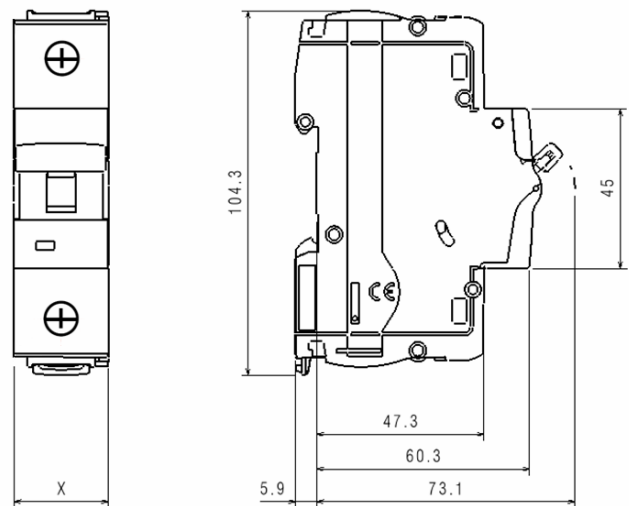

N° of poles	"X" (mm)
1P	26,7 mm
2P	53,4 mm
3P	80,1 mm
4P	106,8 mm

4. PREPARATION - CONNECTION

Fixing:

- . On symmetric rail EN/IEC 60715 or DIN 35.

Operating position:

- . Vertical Horizontal Upside down on the side

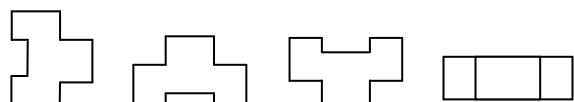

DX³ MCB 25kA up to 63A (1,5 modules per pole)

Cat N°(s): 4 097 20 to 4 098 95

4. PREPARATION – CONNECTION *(continued)*

Supply:

- . Either from the top or from the bottom.

Terminal depth:

- . 19 mm.
- . It is possible to separate the terminals by retractable insulation shields.

Stripping length recommended:

- . 17 mm for main terminals.

Screw head:

- . Mixed, slotted and Pozidriv n°2.

Tightening torque:

- . Recommended: 3 Nm.
- . Mini 2,5 Nm.
- . Maxi 3,5 Nm.

Tools required:

- . For the terminals: Pozidriv n°2 or flat screwdriver 5,5 mm (6 mm maximum).
- . For fixing: flat screwdriver 5,5 mm (6 mm maximum).

Connectable section:

	Copper cable	
	Without ferrule	Without ferrule
Rigid cable	1 x 1,5mm ² to 50mm ² 2 x 1,5mm ² to 16mm ²	-
Flexible cable	1 x 1,5mm ² to 35mm ² 2 x 1,5mm ² to 10mm ²	1 x 1,5mm ² to 35mm ²

Manual actuation of the MCB:

- . Ergonomic 2 position handle:
0 / OFF: Device open.
I / ON: Device closed.

Contact status display:

- . By marking of the associated m.c.b. handle:
"O-Off" white on a green background = contacts opened.
"I-On" white on a red background = contacts closed.
- . By mechanical indicator on front face:
Green = contacts opened.
Red = contacts closed.

Sealing:

- . Possible in "Open" position (OFF) or "Close" position (ON).

Lockout::

- . By 5 mm padlock (cat. n° 4 063 13) or 6 mm padlock (cat. n° 0 227 97) with padlock support (cat. n° 4 063 03) in "Open" position

Consignment:

- . On site padlocking system, possible only open circuit - 0 / OFF handle position - with 1,5mm² stripped wire for example or 2,4mm wide colring.

4. PREPARATION – CONNECTION *(continued)*

Labelling:

- . Circuit identification by way of a label inserted in the label holder situated on the product.

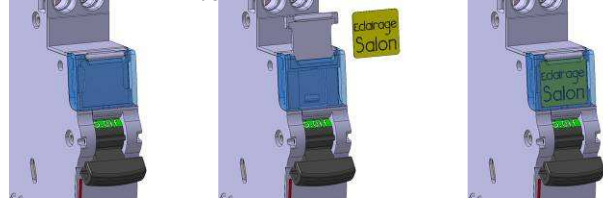

5. GENERAL CHARACTERISTICS

Front side marking:

- . By permanent ink pad printing showing:
 - Trade name: DX³
 - Breaking curve
 - Rated current (in A)
 - Icu in kA, Breaking capacity according to IEC/ EN 60947-2 standard (25kA)
 - Catalogue number and logo 
 - Mark: Legrand

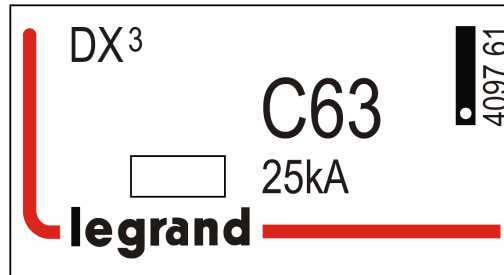

Short-circuit breaking capacity:

- . Alternate current 50/60Hz, single-phase or three-phase network, according to IEC 60947-2. B, C, D and MA curves

Un		1P	2P	3P / 4P
110 V~	Icu	36 kA	72 kA	-
230 V~		25 kA	50 kA	50 kA
400 V~		-	25 kA	25 kA
440 V~		-	20 kA	20 kA
500 V~		-	10 kA	10 kA

Un		1P	2P	3P / 4P
110 V~	Ics	75% of Icu	75% of Icu	75% of Icu
230 V~				
400 V~				

Short-circuit breaking capacity of only one pole:

- . Three-phase network 220 / 380 V~ to 240 / 415 V~
 - In TN neutral system, Icn1 = 25 kA (under 220 to 240 V~)
 - In IT neutral system, Iit = 6,25 kA (under 380 to 415 V~)
- . Three-phase network 110 / 220 V~ to 120 / 240 V~
 - In TN neutral system, Icn1 = 50 kA (under 110 to 127 V~)
 - In IT neutral system, Iit = 12,5 kA (under 220 to 240 V~)

DX³ MCB 25kA up to 63A (1,5 modules per pole)

Cat N°(s): 4 097 20 to 4 098 95

5. GENERAL CHARACTERISTICS (continued)

Short-circuit breaking capacity: (continued)

. Direct current according to standard IEC 60947-2

Un		1P	2P	3P	4P
24 ÷ 48 V d.c.	Icu	25 kA	25 kA	-	-
110 V d.c.		-	25 kA	25 kA	-
230 V d.c.		-	-	-	25 kA
24 ÷ 48 V d.c.	Ics	25 kA	25 kA	-	-
110 V d.c.		-	25 kA	25 kA	-
230 V d.c.		-	-	-	25 kA

Minimum operating voltage :

. 12 V a.c. / d.c. per pole.

Pulse rated voltage:

. U_{imp} = 6 kV (wave 1.5 / 50 μs).

Insulation rated voltage:

. U_i = 500 V.

Pollution degree::

. 3.

Dielectric strength:

. 2500 V.

Operation at 400Hz:

. The magnetic thresholds increase by 45%.

Load to close and to open of a pole trough the handle:

. 0,17 Nm per pole to close.

. 0,09 Nm per pole to open.

Mechanical endurance according to IEC 60947-2 :

. 20 000 operations without load

. 10 000 operations with load (under I_n x Cos φ=0.9)

. 2 000 operations with load (under I_n in DC current)

Enclosure material:

. Polyester.

. Characteristics of this material: self extinguishing, heat and fire resistant according to EN 60898-1, glow-wire test at 960°C for external parts made of insulating material necessary to retain in position current-carrying parts and parts of protective circuit (650°C for all other external parts made of insulating material).

5. GENERAL CHARACTERISTICS (continued)

Average weight per pole:

. 0,220 kg.

Volume when packed:

	Volume (dm ³)
Single pole	0,36
Double pole	0,63
Triple / Four pole	1,14

Ambient operating temperature:

. Min. = -25°C. Max. = +70°C

Ambient storage temperature:

. Min. = -40°C. Max. = +70°C

Protection class:

. Protection index of terminals against solid and liquid bodies:

IP 20 (according to IEC 529, EN 60529 et NF C 20-010).

. Protection index of the box against solid and liquid bodies:

IP 40 (according to IEC 529, EN 60529 et NF C 20-010).

. Protection index against mechanical shocks:

IK 02 (according to EN 50102 et NF C 20-015).

Resistance to sinusoidal vibrations:

. According to IEC 60068-2-35.

. Axis : x, y, z.

. Frequency range: 5÷100 Hz ; duration 90 minutes

. Displacement (5÷13,2 Hz) : 1mm.

. Acceleration (13,2÷100 Hz) : 0,7g (g=9,81 m/s²)

Recognition:

. Recognition of the circuit by insertion of a label in the label holder.

Power dissipated per pole at I_n (in W) :

. mcbs B, C and D curves

I _n	16 A	20 A	25 A	32 A	40 A	50 A	63 A
1P ÷ 4P	2,75	4,72	2,8	4,4	4,6	4,32	6,05

. mcb MA curve

I _n	12,5 A	16 A	25 A	40 A	63 A
2P ÷ 4P	2,2	2,75	2,8	4,6	6,05

. Impedance per pole (Ω) = $\frac{\text{Power dissipated}}{I_n^2}$

DX³ MCB 25kA up to 63A (1,5 modules per pole)

Cat N°(s): 4 097 20 to 4 098 95

5. GENERAL CHARACTERISTICS *(continued)*

Derating of circuit-breakers according to ambient temperature :

. The nominal characteristics of a circuit breaker are modified according to the ambient temperature inside the cabinet or the enclosure where the circuit breaker is located.

. Reference temperature: 40°C according IEC/EN 60947-2.

In (A)	Ambient temperature / In									
	- 25°C	- 10°C	0°C	10°C	20°C	30°C	40°C	50°C	60°C	70°C
16	21.9	20.0	18.7	18.0	17.3	16.6	16.0	15.4	14.7	14.1
20	27.7	25.0	23.2	22.4	21.6	20.8	20.0	19.2	18.4	17.6
25	34.5	31.5	29.5	28.3	27.2	26.0	25.0	24.0	22.7	21.7
30	41.7	38.3	36.0	34.5	33.0	31.5	30.0	28.8	27.3	26.1
32	45.8	41.0	37.8	36.5	34.9	33.3	32.0	30.7	29.1	27.8
40	55.5	51.0	48.0	46.0	44.0	42.0	40.0	38.0	36.0	34.0
50	70.0	64.0	60.0	57.5	55.0	52.5	50.0	47.5	45.0	42.5
63	88.1	80.6	75.6	72.5	69.9	66.1	63.0	59.8	56.1	52.9

Derating of MCB for use with fluorescent lights:

Ferromagnetic and electronic ballasts have a high inrush current for a short time. These currents can cause the tripping of circuit breakers. At the time of the installation, it should take into account the maximum number of ballasts per circuit breaker that the manufacturers of lamps and ballasts indicate in their catalogues.

Influence of the altitude:

	≤2000 m	3000 m	4000 m	5000 m
Dielectric holding	3000 V	2500 V	2000 V	1500 V
Max operational Voltage	400 V	400 V	400 V	400 V
Derating at 40°C	none	none	none	none

Derating of MCBs function of the number of devices side by side:

When several MCBs are juxtaposed and operate simultaneously, the thermal evacuation of the poles is limited. This results in an increase in operating temperature of the circuit breakers which can cause unwanted tripping. It is recommended to apply the following coefficients to the rated currents.

Number of circuit breakers side by side	Coefficient
2 - 3	0.9
4 - 5	0.8
6 - 9	0.7
≥ 10	0.6

These values are given by the recommendation of IEC 60439-1, NF C 63421 and EN 60439-1 standards.

To avoid to have to use these coefficients, it is necessary to allow a good ventilation and to separate the devices with 0.5 module spacing elements (cat. N° 4 063 07).

(1,5 modules per pole)

5. GENERAL CHARACTERISTICS (continued):

MCB's back-up protection in three-phase network (+ neutral) 400 / 415 V~ according to IEC/EN 60947-2:

For TT or TN neutral system in 230/400 V network, to know the breaking capacity of the combination of a double pole breaker (connected between phase and neutral under 230V) downstream of a triple-pole circuit-breaker, take the values shown in Tables 230/400V.

		Fuse upstream									
		gG type									
m.c.b. downstream		≤20A	25A	32A	40A	50A	63A	80A	100A	125A	160A
DX ³ 25kA B, C and D curves	16A	-	100kA	100kA	100kA	100kA	100kA	100kA	100kA	100kA	100kA
	20A	-	-	100kA	100kA	100kA	100kA	100kA	100kA	100kA	100kA
	25A	-	-	-	100kA	100kA	100kA	100kA	100kA	100kA	100kA
	32A	-	-	-	-	100kA	100kA	100kA	100kA	100kA	100kA
	40A	-	-	-	-	-	100kA	100kA	100kA	100kA	100kA
	50A	-	-	-	-	-	-	100kA	100kA	100kA	100kA
	63A	-	-	-	-	-	-	-	100kA	100kA	100kA

		Fuse upstream									
		aM type									
m.c.b. downstream		≤20A	25A	32A	40A	50A	63A	80A	100A	125A	160A
DX ³ 25kA B, C and D curves	16A	-	100kA	100kA	100kA	100kA	100kA	100kA	100kA	100kA	100kA
	20A	-	-	100kA	100kA	100kA	100kA	100kA	100kA	100kA	100kA
	25A	-	-	-	100kA	100kA	100kA	100kA	100kA	100kA	100kA
	32A	-	-	-	-	100kA	100kA	100kA	100kA	100kA	100kA
	40A	-	-	-	-	-	100kA	100kA	100kA	100kA	100kA
	50A	-	-	-	-	-	-	100kA	100kA	100kA	100kA
	63A	-	-	-	-	-	-	-	100kA	100kA	100kA

All these values are also valid for circuit breakers associated to differential blocks.

According to the curves and ratings of circuit breakers, attention to the magnetic threshold and to the size of upstream circuit breakers which must necessarily be higher.

DX³ MCB 25kA up to 63A (1,5 modules per pole)

Cat N°(s): 4 097 20 to 4 098 95

5. GENERAL CHARACTERISTICS *(continued)*:

MCB's back-up protection in three-phase network (+ neutral) 400 / 415 V~ according to IEC/EN 60947-2:

For TT or TN neutral system in 230/400 V network, to know the breaking capacity of the combination of a double pole breaker (connected between phase and neutral under 230V) downstream of a triple-pole circuit-breaker, take the values shown in Tables 230/400V.

		m.c.b. upstream										
		DX ³ 36kA						DX ³ 50kA				
		C curve						B, C and D curves				
m.c.b. downstream		≤25A	32A	40A	50A	63A	80A	≤25A	32A	40A	50A	63A
DX ³ 25kA B and C curves	32A	-	-	36kA	36kA	36kA	36kA	-	-	50kA	50kA	50kA
	40A	-	-	-	36kA	36kA	36kA	-	-	-	50kA	50kA
	50A	-	-	-	-	36kA	36kA	-	-	-	-	50kA
	63A	-	-	-	-	-	36kA	-	-	-	-	-

		m.c.b. upstream										
		DX ³ 36kA						DX ³ 50kA				
		C curve						B and C curves				
m.c.b. downstream		≤25A	32A	40A	50A	63A	80A	≤25A	32A	40A	50A	63A
DX ³ 25kA D curve	16A	-	36kA	36kA	36kA	36kA	36kA	-	50kA	50kA	50kA	50kA
	20A	-	-	36kA	36kA	36kA	36kA	-	-	50kA	50kA	50kA
	25A	-	-	-	36kA	36kA	36kA	-	-	-	50kA	50kA
	32A	-	-	-	-	36kA	36kA	-	-	-	-	50kA
	40A	-	-	-	-	-	36kA	-	-	-	-	-
	50A	-	-	-	-	-	-	-	-	-	-	-
	63A	-	-	-	-	-	-	-	-	-	-	-

		m.c.b. upstream				
		DX ³ 50kA				
		D curve				
m.c.b. downstream		≤25A	32A	40A	50A	63A
DX ³ 25kA D curve	16A	50kA	50kA	50kA	50kA	50kA
	20A	50kA	50kA	50kA	50kA	50kA
	25A	-	50kA	50kA	50kA	50kA
	32A	-	-	50kA	50kA	50kA
	40A	-	-	-	50kA	50kA
	50A	-	-	-	-	50kA
	63A	-	-	-	-	-

All these values are also valid for circuit breakers associated to differential blocks.

According to the curves and ratings of circuit breakers, attention to the magnetic threshold and to the size of upstream circuit breakers which must necessarily be higher.

DX³ MCB 25kA up to 63A (1,5 modules per pole)

Cat N°(s): 4 097 20 to 4 098 95

5. GENERAL CHARACTERISTICS *(continued)*:

MCB's back-up protection in three-phase network (+ neutral) 400 / 415 V~ according to IEC/EN 60947-2:

For TT or TN neutral system in 230/400 V network, to know the breaking capacity of the combination of a double pole breaker (connected between phase and neutral under 230V) downstream of a triple-pole circuit-breaker, take the values shown in Tables 230/400V.

m.c.b. downstream		m.c.b. upstream													
		DPX 125						DPX ³ 160 / DPX ³ 160 + diff.							
		36kA						50kA							
		16A	25A	40A	63A	100A	125A	16A	25A	40A	63A	80A	100A	125A	160A
DX ³ 25kA B, C and D curves	16A	-	30kA	30kA	30kA	30kA	30kA	-	36kA	36kA	36kA	36kA	36kA	36kA	36kA
	20A	-	30kA	30kA	30kA	30kA	30kA	-	36kA	36kA	36kA	36kA	36kA	36kA	36kA
	25A	-	-	30kA	30kA	30kA	30kA	-	-	36kA	36kA	36kA	36kA	36kA	36kA
	32A	-	-	30kA	30kA	30kA	30kA	-	-	36kA	36kA	36kA	36kA	36kA	36kA
	40A	-	-	-	30kA	30kA	30kA	-	-	-	36kA	36kA	36kA	36kA	36kA
	50A	-	-	-	30kA	30kA	30kA	-	-	-	36kA	36kA	36kA	36kA	36kA
	63A	-	-	-	-	30kA	30kA	-	-	-	-	36kA	36kA	36kA	36kA

m.c.b. downstream		m.c.b. upstream											
		DPX 160					DPX 250ER			DPX 250ER AB			
		36 - 50kA					36 - 50kA			36kA			
		25A	40A	63A	100A	125A	100A	160A	250A	90A	130A	170A	240A
DX ³ 25kA B, C and D curves	16A	30kA	30kA	30kA	30kA	30kA	30kA	30kA	30kA	30kA	30kA	30kA	30kA
	20A	30kA	30kA	30kA	30kA	30kA	30kA	30kA	30kA	30kA	30kA	30kA	30kA
	25A	-	30kA	30kA	30kA	30kA	30kA	30kA	30kA	30kA	30kA	30kA	30kA
	32A	-	-	30kA	30kA	30kA	30kA	30kA	30kA	30kA	30kA	30kA	30kA
	40A	-	-	30kA	30kA	30kA	30kA	30kA	30kA	30kA	30kA	30kA	30kA
	50A	-	-	-	30kA	30kA	30kA	30kA	30kA	30kA	30kA	30kA	30kA
	63A	-	-	-	30kA	30kA	30kA	30kA	30kA	30kA	30kA	30kA	30kA

All these values are also valid for circuit breakers associated to differential blocks.

According to the curves and ratings of circuit breakers, attention to the magnetic threshold and to the size of upstream circuit breakers which must necessarily be higher.

DX³ MCB 25kA up to 63A (1,5 modules per pole)

Cat N°(s): 4 097 20 to 4 098 95

5. GENERAL CHARACTERISTICS *(continued)*:

MCB's back-up protection in three-phase network (+ neutral) 400 / 415 V~ according to IEC/EN 60947-2:

For TT or TN neutral system in 230/400 V network, to know the breaking capacity of the combination of a double pole breaker (connected between phase and neutral under 230V) downstream of a triple-pole circuit-breaker, take the values shown in Tables 230/400V.

		m.c.b. upstream					
		DPX ³ 250 / DPX ³ 250+diff.				DPX 400AB	
		36 - 70kA				36kA	
m.c.b. downstream		100A	160A	200A	250A	320A	400A
DX ³ 25kA B, C and D curves	16A	36kA	36kA	36kA	36kA	36kA	36kA
	20A	36kA	36kA	36kA	36kA	36kA	36kA
	25A	36kA	36kA	36kA	36kA	36kA	36kA
	32A	36kA	36kA	36kA	36kA	36kA	36kA
	40A	36kA	36kA	36kA	36kA	36kA	36kA
	50A	36kA	36kA	36kA	36kA	36kA	36kA
	63A	36kA	36kA	36kA	36kA	36kA	36kA

All these values are also valid for circuit breakers associated to differential blocks.

According to the curves and ratings of circuit breakers, attention to the magnetic threshold and to the size of upstream circuit breakers which must necessarily be higher.

DX³ MCB 25kA up to 63A (1,5 modules per pole)

Cat N°(s): 4 097 20 to 4 098 95

5. GENERAL CHARACTERISTICS *(continued)*:

MCB's back-up protection in three-phase network (+ neutral) 400 / 415 V~ according to IEC/EN 60947-2:

For TT or TN neutral system in 230/400 V network, to know the breaking capacity of the combination of a double pole breaker (connected between phase and neutral under 230V) downstream of a triple-pole circuit-breaker, take the values shown in Tables 230/400V.

		m.c.c.b. upstream										
		DPX / H / L 250						DPX / DPXH / DPXL 630MT				
		36 – 70 – 100kA						36 – 70 – 100kA				
m.c.b. downstream		25A	40A	63A	100A	160A	250A	250A	320A	400A	500A	630A
DX ³ 25kA B and C curves	32A	-	36kA	36kA	36kA	36kA	36kA	36kA	36kA	36kA	36kA	36kA
	40A	-	-	36kA	36kA	36kA	36kA	36kA	36kA	36kA	36kA	36kA
	50A	-	-	36kA	36kA	36kA	36kA	36kA	36kA	36kA	36kA	36kA
	63A	-	-	-	36kA	36kA	36kA	36kA	36kA	36kA	36kA	36kA

		m.c.c.b. upstream										
		DPX / H / L 250						DPX / DPXH / DPXL 630MT				
		36 – 70 – 100kA						36 – 70 – 100kA				
m.c.b. downstream		25A	40A	63A	100A	160A	250A	250A	320A	400A	500A	630A
DX ³ 25kA D curve	16A	36kA	36kA	36kA	36kA	36kA	36kA	36kA	36kA	36kA	36kA	36kA
	20A	36kA	36kA	36kA	36kA	36kA	36kA	36kA	36kA	36kA	36kA	36kA
	25A	-	36kA	36kA	36kA	36kA	36kA	36kA	36kA	36kA	36kA	36kA
	32A	-	36kA	36kA	36kA	36kA	36kA	36kA	36kA	36kA	36kA	36kA
	40A	-	-	36kA	36kA	36kA	36kA	36kA	36kA	36kA	36kA	36kA
	50A	-	-	36kA	36kA	36kA	36kA	36kA	36kA	36kA	36kA	36kA
	63A	-	-	-	36kA	36kA	36kA	36kA	36kA	36kA	36kA	36kA

		m.c.c.b. upstream													
		DPX 125							DPX ³ 160 / DPX ³ 160 + diff.						
		36kA							50kA						
m.c.b. downstream		16A	25A	40A	63A	100A	125A	16A	25A	40A	63A	80A	100A	125A	160A
DX ³ 25kA MA curve	12,5A	30kA	30kA	30kA	30kA	30kA	30kA	36kA	36kA	36kA	36kA	36kA	36kA	36kA	36kA
	16A	-	30kA	30kA	30kA	30kA	30kA	-	36kA	36kA	36kA	36kA	36kA	36kA	36kA
	25A	-	-	30kA	30kA	30kA	30kA	-	-	36kA	36kA	36kA	36kA	36kA	36kA
	40A	-	-	-	30kA	30kA	30kA	-	-	-	36kA	36kA	36kA	36kA	36kA
	63A	-	-	-	-	30kA	30kA	-	-	-	-	36kA	36kA	36kA	36kA

All these values are also valid for circuit breakers associated to differential blocks.

According to the curves and ratings of circuit breakers, attention to the magnetic threshold and to the size of upstream circuit breakers which must necessarily be higher.

DX³ MCB 25kA up to 63A (1,5 modules per pole)

Cat N°(s): 4 097 20 to 4 098 95

5. GENERAL CHARACTERISTICS *(continued)*:

MCB's back-up protection in three-phase network (+ neutral) 400 / 415 V~ according to IEC/EN 60947-2:

For TT or TN neutral system in 230/400 V network, to know the breaking capacity of the combination of a double pole breaker (connected between phase and neutral under 230V) downstream of a triple-pole circuit-breaker, take the values shown in Tables 230/400V.

		m.c.c.b. upstream											
		DPX 160					DPX 250ER			DPX 250ER AB			
		36 - 50kA					36 - 50kA			36kA			
m.c.b. downstream		25A	40A	63A	100A	125A	100A	160A	250A	90A	130A	170A	240A
DX ³ 25kA MA curve	12,5A	30kA	30kA	30kA	30kA	30kA	30kA	30kA	30kA	30kA	30kA	30kA	30kA
	16A	30kA	30kA	30kA	30kA	30kA	30kA	30kA	30kA	30kA	30kA	30kA	30kA
	25A	-	30kA	30kA	30kA	30kA	30kA	30kA	30kA	30kA	30kA	30kA	30kA
	40A	-	-	30kA	30kA	30kA	30kA	30kA	30kA	30kA	30kA	30kA	30kA
	63A	-	-	-	30kA	30kA	30kA	30kA	30kA	30kA	30kA	30kA	30kA

		m.c.c.b. upstream											
		DPX ³ 250 / DPX ³ 250+diff.					DPX / H / L 250						DPX 400AB
		36 - 70kA					36 - 70 - 100kA						36kA
m.c.b. downstream		100A	160A	200A	250A	25A	40A	63A	100A	160A	250A	320A	400A
DX ³ 25kA MA curve	12,5A	36kA	36kA	36kA	36kA	36kA	36kA	36kA	36kA	36kA	36kA	36kA	36kA
	16A	36kA	36kA	36kA	36kA	36kA	36kA	36kA	36kA	36kA	36kA	36kA	36kA
	25A	36kA	36kA	36kA	36kA	36kA	36kA	36kA	36kA	36kA	36kA	36kA	36kA
	40A	36kA	36kA	36kA	36kA	36kA	36kA	36kA	36kA	36kA	36kA	36kA	36kA
	63A	36kA	36kA	36kA	36kA	36kA	36kA	36kA	36kA	36kA	36kA	36kA	36kA

		m.c.c.b. upstream				
		DPX / DPXH / DPXL 630MT				
		36 - 70 - 100kA				
m.c.b. downstream		250A	320A	400A	500A	630A
DX ³ 25kA MA curve	12,5A	36kA	36kA	36kA	36kA	36kA
	16A	36kA	36kA	36kA	36kA	36kA
	25A	36kA	36kA	36kA	36kA	36kA
	40A	36kA	36kA	36kA	36kA	36kA
	63A	36kA	36kA	36kA	36kA	36kA

All these values are also valid for circuit breakers associated to differential blocks.

According to the curves and ratings of circuit breakers, attention to the magnetic threshold and to the size of upstream circuit breakers which must necessarily be higher.

DX³ MCB 25kA up to 63A (1,5 modules per pole)

Cat N°(s): 4 097 20 to 4 098 95

5. GENERAL CHARACTERISTICS *(continued)*:

MCB's back-up protection in three-phase network (+ neutral) 230 / 240 V~ according to IEC/EN 60947-2:

		Fuse upstream									
		gG type									
m.c.b. downstream		≤20A	25A	32A	40A	50A	63A	80A	100A	125A	160A
DX ³ 25kA B, C and D curves	16A	-	100kA	100kA	100kA	100kA	100kA	100kA	100kA	100kA	100kA
	20A	-	-	100kA	100kA	100kA	100kA	100kA	100kA	100kA	100kA
	25A	-	-	-	100kA	100kA	100kA	100kA	100kA	100kA	100kA
	32A	-	-	-	-	100kA	100kA	100kA	100kA	100kA	100kA
	40A	-	-	-	-	-	100kA	100kA	100kA	100kA	100kA
	50A	-	-	-	-	-	-	100kA	100kA	100kA	100kA
	63A	-	-	-	-	-	-	100kA	100kA	100kA	100kA

		Fuse upstream									
		aM type									
m.c.b. downstream		≤20A	25A	32A	40A	50A	63A	80A	100A	125A	160A
DX ³ 25kA B, C and D curves	16A	-	100kA	100kA	100kA	100kA	100kA	100kA	100kA	100kA	100kA
	20A	-	-	100kA	100kA	100kA	100kA	100kA	100kA	100kA	100kA
	25A	-	-	-	100kA	100kA	100kA	100kA	100kA	100kA	100kA
	32A	-	-	-	-	100kA	100kA	100kA	100kA	100kA	100kA
	40A	-	-	-	-	-	100kA	100kA	100kA	100kA	100kA
	50A	-	-	-	-	-	-	100kA	100kA	100kA	100kA
	63A	-	-	-	-	-	-	100kA	100kA	100kA	100kA

Coordination between modular circuit-breakers, three-phase network (+ neutral) 230 / 240 V~ according to IEC/EN 60947-2:

		m.c.b. upstream										
		DX ³ 36kA					DX ³ 50kA					
		C curve					B, C and D curves					
m.c.b. downstream		≤25A	32A	40A	50A	63A	80A	≤25A	32A	40A	50A	63A
DX ³ 25kA B and C curves	32A	-	-	60kA	60kA	60kA	60kA	-	-	70kA	70kA	70kA
	40A	-	-	-	60kA	60kA	60kA	-	-	-	70kA	70kA
	50A	-	-	-	-	60kA	60kA	-	-	-	-	70kA
	63A	-	-	-	-	-	60kA	-	-	-	-	-

All these values are also valid for circuit breakers associated to differential blocks.

According to the curves and ratings of circuit breakers, attention to the magnetic threshold and to the size of upstream circuit breakers which must necessarily be higher.

DX³ MCB 25kA up to 63A (1,5 modules per pole)

Cat N°(s): 4 097 20 to 4 098 95

5. GENERAL CHARACTERISTICS *(continued)*

MCB's back-up protection in three-phase network (+ neutral) 230 / 240 V~ according to IEC/EN 60947-2:

m.c.b. downstream		m.c.b. upstream										
		DX ³ 36kA						DX ³ 50kA				
		C Curve						B and C curves				
		≤25A	32A	40A	50A	63A	80A	≤25A	32A	40A	50A	63A
DX ³ 25kA Curve D	16A	-	60kA	60kA	60kA	60kA	60kA	-	70kA	70kA	70kA	70kA
	20A	-	-	60kA	60kA	60kA	60kA	-	-	70kA	70kA	70kA
	25A	-	-	-	60kA	60kA	60kA	-	-	-	70kA	70kA
	32A	-	-	-	-	60kA	60kA	-	-	-	-	70kA
	40A	-	-	-	-	-	60kA	-	-	-	-	-
	50A	-	-	-	-	-	-	-	-	-	-	-
	63A	-	-	-	-	-	-	-	-	-	-	-

m.c.b. downstream		m.c.b. upstream				
		DX ³ 50kA				
		D curve				
		≤25A	32A	40A	50A	63A
DX ³ 25kA D curve	16A	70kA	70kA	70kA	70kA	70kA
	20A	70kA	70kA	70kA	70kA	70kA
	25A	-	70kA	70kA	70kA	70kA
	32A	-	-	70kA	70kA	70kA
	40A	-	-	-	70kA	70kA
	50A	-	-	-	-	70kA
	63A	-	-	-	-	-

All these values are also valid for circuit breakers associated to differential blocks.

According to the curves and ratings of circuit breakers, attention to the magnetic threshold and to the size of upstream circuit breakers which must necessarily be higher.

DX³ MCB 25kA up to 63A (1,5 modules per pole)

Cat N°(s): 4 097 20 to 4 098 95

5. GENERAL CHARACTERISTICS *(continued)*

MCB's back-up protection in three-phase network (+ neutral) 230 / 240 V~ according to IEC/EN 60947-2:

		m.c.c.b. upstream							
		DPX ³ 160 / DPX ³ 160 + diff.							
		50kA							
m.c.b. downstream		16A	25A	40A	63A	80A	100A	125A	160A
DX ³ 25kA B and C Curves	32A	-	-	65kA	65kA	65kA	65kA	65kA	65kA
	40A	-	-	-	65kA	65kA	65kA	65kA	65kA
	50A	-	-	-	65kA	65kA	65kA	65kA	65kA
	63A	-	-	-	-	65kA	65kA	65kA	65kA

		m.c.c.b. upstream							
		DPX ³ 160 / DPX ³ 160 + diff.							
		50kA							
m.c.b. downstream		16A	25A	40A	63A	80A	100A	125A	160A
DX ³ 25kA D curve	16A	-	65kA	65kA	65kA	65kA	65kA	65kA	65kA
	20A	-	65kA	65kA	65kA	65kA	65kA	65kA	65kA
	25A	-	-	65kA	65kA	65kA	65kA	65kA	65kA
	32A	-	-	65kA	65kA	65kA	65kA	65kA	65kA
	40A	-	-	-	65kA	65kA	65kA	65kA	65kA
	50A	-	-	-	65kA	65kA	65kA	65kA	65kA
	63A	-	-	-	-	65kA	65kA	65kA	65kA

		m.c.c.b. upstream											
		DPX 160					DPX 250ER			DPX ³ 250 / DPX ³ 250 + diff.			
		50kA					50kA			70kA			
m.c.b. downstream		25A	40A	63A	100A	125A	100A	160A	250A	100A	160A	200A	250A
DX ³ 25kA B, C and D curves	16A	55kA	55kA	55kA	55kA	55kA	55kA	55kA	55kA	55kA	55kA	55kA	55kA
	20A	55kA	55kA	55kA	55kA	55kA	55kA	55kA	55kA	55kA	55kA	55kA	55kA
	25A	-	55kA	55kA	55kA	55kA	55kA	55kA	55kA	55kA	55kA	55kA	55kA
	32A	-	55kA	55kA	55kA	55kA	55kA	55kA	55kA	55kA	55kA	55kA	55kA
	40A	-	-	55kA	55kA	55kA	55kA	55kA	55kA	55kA	55kA	55kA	55kA
	50A	-	-	55kA	55kA	55kA	55kA	55kA	55kA	55kA	55kA	55kA	55kA
	63A	-	-	-	55kA	55kA	55kA	55kA	55kA	55kA	55kA	55kA	55kA

All these values are also valid for circuit breakers associated to differential blocks.

According to the curves and ratings of circuit breakers, attention to the threshold and size of upstream fuse which must necessarily be higher

DX³ MCB 25kA up to 63A (1,5 modules per pole)

Cat N°(s): 4 097 20 to 4 098 95

5. GENERAL CHARACTERISTICS *(continued)*

MCB's back-up protection in three-phase network (+ neutral) 230 / 240 V~ according to IEC/EN 60947-2:

m.c.b. downstream		m.c.c.b. upstream											
		DPX 250						DPX H / L 250					
		36kA						70 – 100kA					
		25A	40A	63A	100A	160A	250A	25A	40A	63A	100A	160A	250A
DX ³ 25kA B, C and D curves	16A	55kA	55kA	55kA	55kA	55kA	55kA	60kA	60kA	60kA	60kA	60kA	60kA
	20A	55kA	55kA	55kA	55kA	55kA	55kA	60kA	60kA	60kA	60kA	60kA	60kA
	25A	-	55kA	55kA	55kA	55kA	55kA	-	60kA	60kA	60kA	60kA	60kA
	32A	-	55kA	55kA	55kA	55kA	55kA	-	60kA	60kA	60kA	60kA	60kA
	40A	-	-	55kA	55kA	55kA	55kA	-	-	60kA	60kA	60kA	60kA
	50A	-	-	55kA	55kA	55kA	55kA	-	-	60kA	60kA	60kA	60kA
	63A	-	-	-	55kA	55kA	55kA	-	-	-	60kA	60kA	60kA

m.c.b. downstream		m.c.c.b. upstream											
		DPX 630MT						DPX H / L 630					
		36kA						70 – 100kA					
		25A	40A	63A	100A	160A	250A	25A	40A	63A	100A	160A	250A
DX ³ 25kA B, C and D curves	16A	55kA	55kA	55kA	55kA	55kA	55kA	60kA	60kA	60kA	60kA	60kA	60kA
	20A	55kA	55kA	55kA	55kA	55kA	55kA	60kA	60kA	60kA	60kA	60kA	60kA
	25A	-	55kA	55kA	55kA	55kA	55kA	-	60kA	60kA	60kA	60kA	60kA
	32A	-	55kA	55kA	55kA	55kA	55kA	-	60kA	60kA	60kA	60kA	60kA
	40A	-	-	55kA	55kA	55kA	55kA	-	-	60kA	60kA	60kA	60kA
	50A	-	-	55kA	55kA	55kA	55kA	-	-	60kA	60kA	60kA	60kA
	63A	-	-	-	55kA	55kA	55kA	-	-	-	60kA	60kA	60kA

All these values are also valid for circuit breakers associated to differential blocks.

According to the curves and ratings of circuit breakers, attention to the magnetic threshold and to the size of upstream circuit breakers which must necessarily be higher.

(1,5 modules per pole)

5. GENERAL CHARACTERISTICS (continued)

Selectivity between two levels of protection

- . The downstream circuit breaker must always have a magnetic threshold and a rated current lower than those of the upstream protection.
- . Selectivity is indicated total (T) if there is selectivity up to the value of breaking capacity (according to IEC / EN 60947-2) of the downstream circuit breaker.

Selectivity between modular circuit breakers and fuses:

- . Selectivity limit at 400V~: values in Ampere.

		Fuse upstream							
		gG type							
m.c.b. downstream		32A	40A	50A	63A	80A	100A	125A	160A
DX ³ 25kA B and C curves	32A	-	-	1200	1700	1900	3500	4500	8000
	40A	-	-	-	-	1700	3000	4000	6000
	50A	-	-	-	-	1600	2600	3500	5000
	63A	-	-	-	-	-	2400	3300	5000

DX ³ 25kA D curve	16A	-	1400	1800	2600	3000	5600	8000	15000
	20A	-	1200	1500	2200	2500	4600	6300	10000
	25A	-	-	1200	1800	2100	3700	5000	6000
	32A	-	-	-	1500	1800	3000	4000	5000
	40A	-	-	-	-	1700	2600	3500	4500
	50A	-	-	-	-	1400	2000	3000	4000
	63A	-	-	-	-	-	2000	3000	4000

		Fuse upstream								
		aM type								
m.c.b. downstream		25A	32A	40A	50A	63A	80A	100A	125A	160A
DX ³ 25kA B and C curves	32A	-	-	-	1300	2400	3800	5000	7700	9000
	40A	-	-	-	-	2100	3100	4200	6400	7000
	50A	-	-	-	-	2000	2900	3700	6000	6000
	63A	-	-	-	-	-	2800	3500	5500	6000

DX ³ 25kA D curve	16A	-	1000	1400	2100	4000	6000	9000	21000	25000
	20A	-	-	1300	1800	3400	5100	7000	14000	20000
	25A	-	-	1000	1500	2700	4000	5500	9000	12000
	32A	-	-	-	1100	2100	3500	4700	7500	10000
	40A	-	-	-	-	1800	2800	4000	6000	7000
	50A	-	-	-	-	1800	2500	3500	5500	6000
	63A	-	-	-	-	-	2500	3500	5500	6000

(1,5 modules per pole)

5. GENERAL CHARACTERISTICS *(continued)*

Selectivity between modular circuit breakers:

. Selectivity limit at 400V~: values in Ampere.

		m.c.b. upstream							
		DX ³ 50kA							
		C curve							
m.c.b. downstream		10A	16A	20A	25A	32A	40A	50A	63A
DX ³ 25kA B and C curves	32A	-	-	-	-	-	300	500	600
	40A	-	-	-	-	-	-	400	600
	50A	-	-	-	-	-	-	-	500
	63A	-	-	-	-	-	-	-	-

DX ³ 25kA D curve	16A	-	-	-	-	300	500	700	1300
	20A	-	-	-	-	-	400	500	1000
	25A	-	-	-	-	-	-	500	800
	32A	-	-	-	-	-	-	-	600
	40A	-	-	-	-	-	-	-	-
	50A	-	-	-	-	-	-	-	-
	63A	-	-	-	-	-	-	-	-

		m.c.b. upstream							
		DX ³ 50kA							
		D curve							
m.c.b. downstream		10A	16A	20A	25A	32A	40A	50A	63A
DX ³ 25kA B, C and D curves	16A	-	-	240	300	384	500	700	1300
	20A	-	-	-	300	384	480	600	1000
	25A	-	-	-	-	384	480	600	800
	32A	-	-	-	-	-	480	600	756
	40A	-	-	-	-	-	-	600	756
	50A	-	-	-	-	-	-	-	756
	63A	-	-	-	-	-	-	-	-

DX³ MCB 25kA up to 63A (1,5 modules per pole)

Cat N°(s): 4 097 20 to 4 098 95

5. GENERAL CHARACTERISTICS *(continued)*

Selectivity between modular circuit breakers and M.C.C.B.s:

. Selectivity limit at 400V~: values in Ampere.

m.c.b. downstream		m.c.c.b. upstream												
		DPX ³ 160E / B / N DPX ³ 160E / B / N + diff.								DPX 160				
		16 - 25 - 50kA								25 - 36 - 50kA				
		16A	25A	40A	63A	80A	100A	125A	160A	25A	40A	63A	100A	160A
DX ³ 25kA B and C curves	32A	-	-	-	T	T	T	T	T	-	-	2000	3500	7000
	40A	-	-	-	T	T	T	T	T	-	-	2000	2500	6000
	50A	-	-	-	4000	4000	5000	10000	10000	-	-	-	2000	5500
	63A	-	-	-	-	3000	5000	10000	10000	-	-	-	2000	5000
DX ³ 25kA D curve	16A	-	T	T	T	T	T	T	T	6000	6000	6000	6000	T
	20A	-	-	T	T	T	T	T	T	-	5000	5000	5000	18000
	25A	-	-	T	T	T	T	T	T	-	3500	4500	4500	8500
	32A	-	-	-	T	T	T	T	T	-	-	4000	4000	7000
	40A	-	-	-	T	T	T	T	T	-	-	3000	3000	6000
	50A	-	-	-	-	4000	5000	10000	10000	-	-	-	3000	5500
	63A	-	-	-	-	3000	5000	10000	10000	-	-	-	3000	5000
DX ³ 25kA MA curve	12,5A	T	T	T	T	T	T	T	T	7000	7000	7500	7500	T
	16A	-	T	T	T	T	T	T	T	6000	6000	6000	6000	T
	25A	-	-	T	T	T	T	T	T	-	3500	4500	4500	8500
	40A	-	-	-	T	T	T	T	T	-	-	3000	3000	6000
	63A	-	-	-	-	3000	5000	10000	10000	-	-	-	3000	6000

DX³ MCB 25kA up to 63A (1,5 modules per pole)

Cat N°(s): 4 097 20 to 4 098 95

5. GENERAL CHARACTERISTICS *(continued)*

Selectivity between modular circuit breakers and M.C.C.B.s:

. Selectivity limit at 400V~: values in Ampere.

		m.c.c.b. upstream												
		DPX 250ER			DPX 250ER AB				DPX 250 / H / L					
		25 - 36 - 50kA			36kA				25 - 70 - 100kA					
m.c.b. downstream		100A	160A	250A	90A	130A	170A	240A	25A	40A	63A	100A	160A	250A
DX ³ 25kA B and C curves	32A	4000	7000	T	T	T	T	T	-	-	2000	5000	T	T
	40A	3500	6000	T	8	T	T	T	-	-	2000	5000	10000	T
	50A	2000	5500	7000	4500	4500	T	T	-	-	-	4000	8000	T
	63A	2000	5000	5000	4500	4500	T	T	-	-	-	4000	8000	T
DX ³ 25kA D curve	16A	6000	T	T	T	T	T	T	-	4000	4000	10000	T	T
	20A	6000	T	T	T	T	T	T	-	4000	4000	8000	T	T
	25A	5500	8500	T	T	T	T	T	-	-	3000	6000	T	T
	32A	4500	7000	T	T	T	T	T	-	-	2000	5000	T	T
	40A	4500	6000	T	8000	T	T	T	-	-	-	5000	10000	T
	50A	3500	5500	T	4000	4000	T	T	-	-	-	4000	8000	T
	63A	3500	5000	6000	4000	4000	T	T	-	-	-	4000	8000	T
DX ³ 25kA MA curve	12,5A	T	T	T	T	T	T	T	5000	5000	5000	T	T	T
	16A	6000	T	T	T	T	T	T	-	4000	4000	10000	T	T
	25A	5500	8500	T	T	T	T	T	-	-	3000	6000	T	T
	40A	4500	6000	T	4500	T	T	T	-	-	-	5000	10000	T
	63A	3500	5000	6000	3500	3500	T	T	-	-	-	4000	8000	T

DX³ MCB 25kA up to 63A (1,5 modules per pole)

Cat N°(s): 4 097 20 to 4 098 95

5. GENERAL CHARACTERISTICS *(continued)*

Selectivity between modular circuit breakers and M.C.C.B.s:

. Selectivity limit at 400V~: values in Ampere.

		m.c.c.b. upstream					
		DPX ³ 250 DPX ³ 250 + diff.				DPX 400AB	
		25 - 36 - 70kA				36kA	
m.c.b. downstream		100A	160A	200A	250A	320A	400A
DX ³ 25kA B and C curves	32A	T	T	T	T	T	T
	40A	T	T	T	T	T	T
	50A	20000	T	T	T	T	T
	63A	15000	T	T	T	T	T
DX ³ 25kA D curve	16A	T	T	T	T	T	T
	20A	T	T	T	T	T	T
	25A	T	T	T	T	T	T
	32A	T	T	T	T	T	T
	40A	T	T	T	T	T	T
	50A	20000	T	T	T	T	T
	63A	15000	T	T	T	T	T
DX ³ 25kA MA curve	12,5A	T	T	T	T	T	T
	16A	T	T	T	T	T	T
	25A	T	T	T	T	T	T
	40A	T	T	T	T	T	T
	63A	-	T	T	T	T	T

6. CONFORMITIES AND APPROVALS

Compliance to standards:

- . Standard reference: IEC/EN 60947-2 with 25 kA breaking capacity
- . CEE guidelines : 73/23/CEE + 93/68/CEE
- . Legrand circuit-breakers can be used under the conditions of use as defined by IEC / EN 60947.
- . The performance of circuit breakers can be influenced by particular climates: hot dry, cold dry, hot humid, salt fog atmosphere

Classification according to Annex Q (standard IEC/EN 60947-1) :

- . Category C with a range test temperature -25 °C / +70 °C
- . salt fog atmosphere according IEC 60068-2-52

Respect of the environment – Compliance with CEE directives:

- . Compliance with Directive 2002/95/EC of 27/01/03 called "RoHS" which provides for the banning of hazardous substances such as lead, mercury, cadmium, hexavalent chromium, brominated flame retardants polybrominated biphenyls (PBBs) and polybrominated diphenyl ethers (PBDEs) from 1st July 2006
- . Compliance with Directive 91/338/CEE of 18/06/91 and Decree 94-647 of 27/07/04

Plastic materials :

- . Halogens-free plastic materials.
- . Marking of parts according to ISO 11469 and ISO 1043.

Packaging:

- . Design and manufacture of packaging in accordance with Decree 98-638 of 07.20.98 and Directive 94/62/EC

DX³ MCB 25kA up to 63A (1,5 modules per pole)

Cat N°(s): 4 097 20 to 4 098 95

7. CURVES

Current limiting curves:

.B, C, D, and MA curves

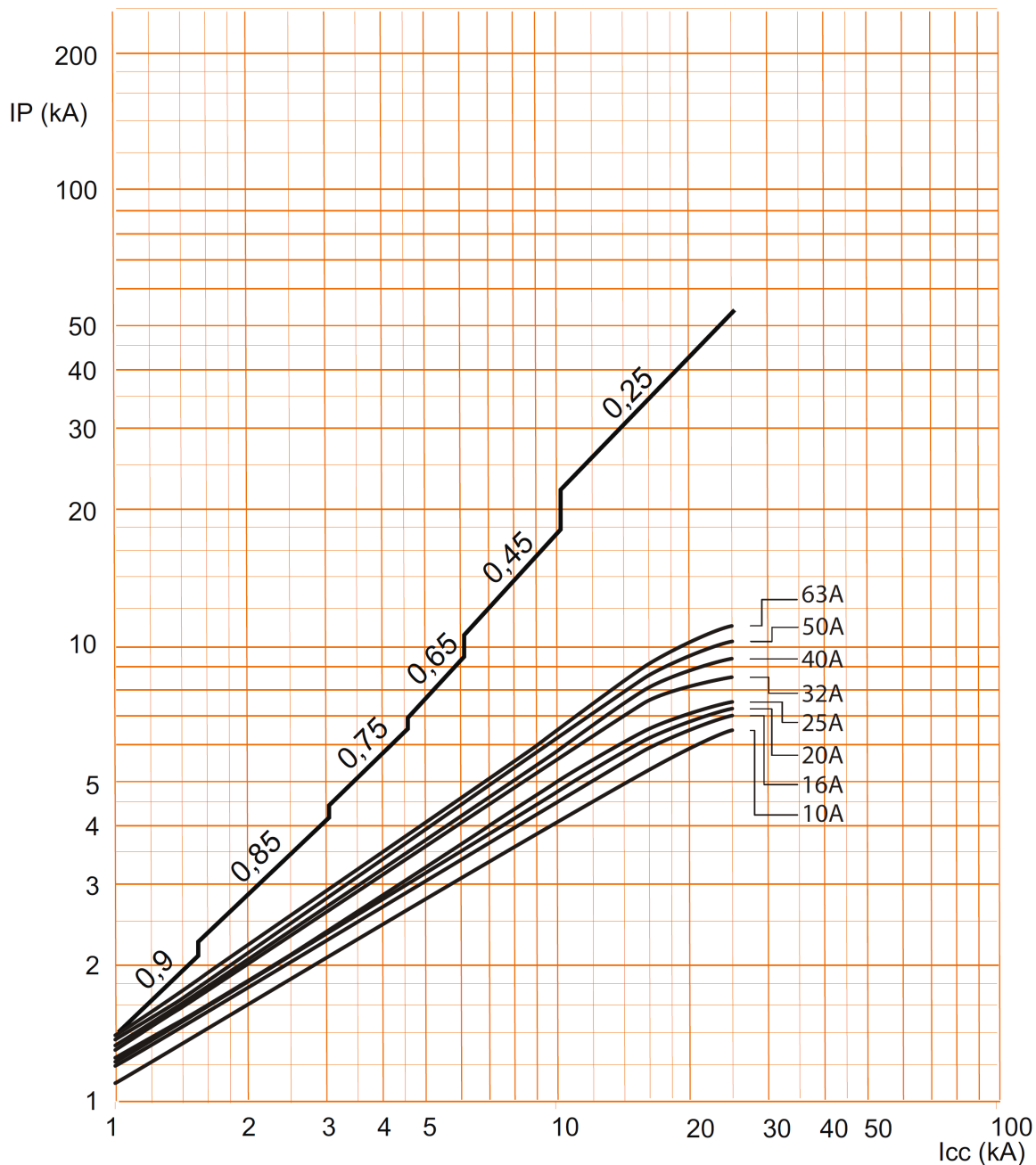

. Icc = Square value of symmetric component of the short circuit current (kA).
 . IP = Max peak value (kA)

7. CURVES (continued)

Operating characteristic of circuit breakers B curve :

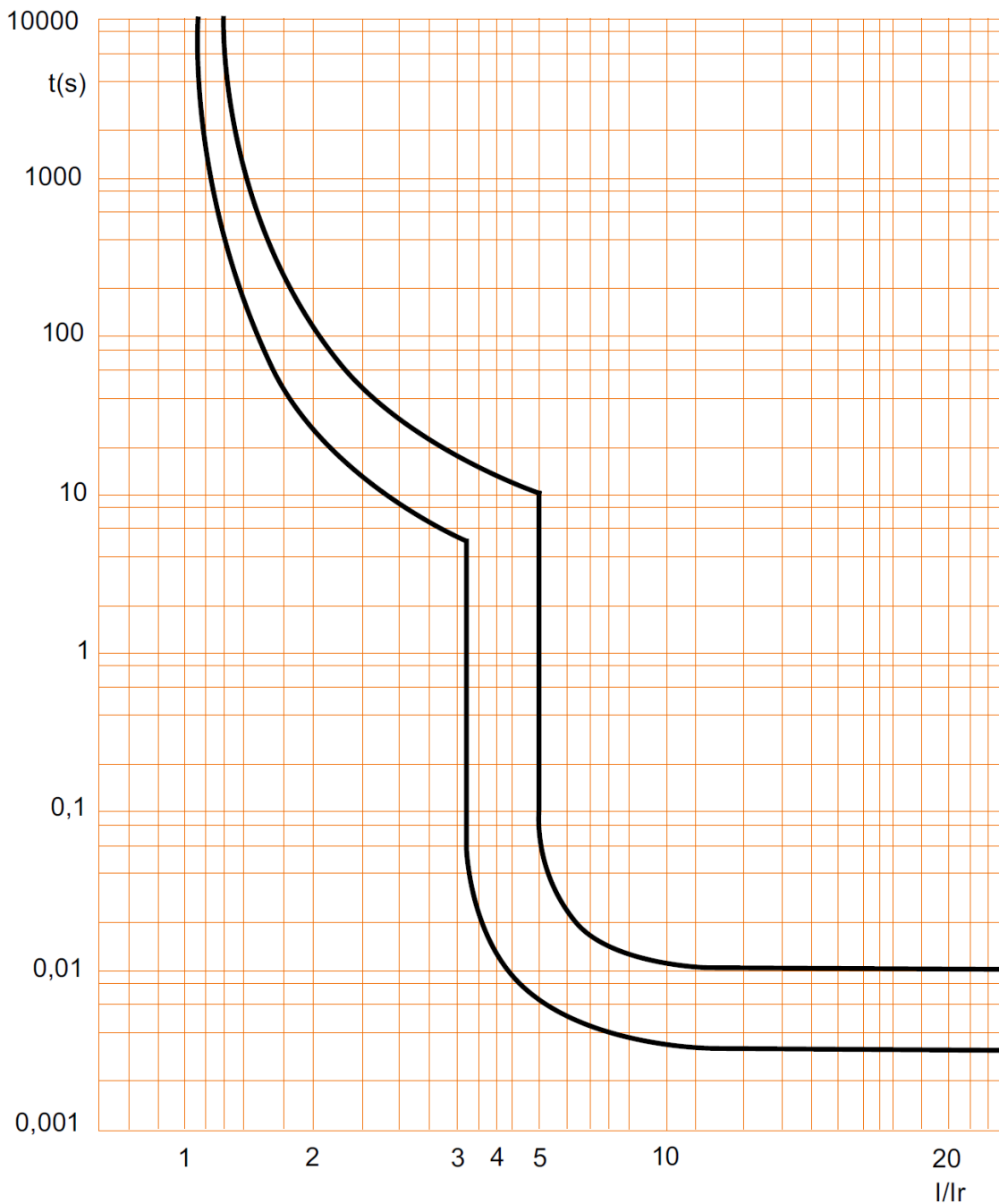

7. CURVES *(continued)*

. Thermal energy limiting curves of circuit breakers B curve, 2P (230V~ / 50Hz) :

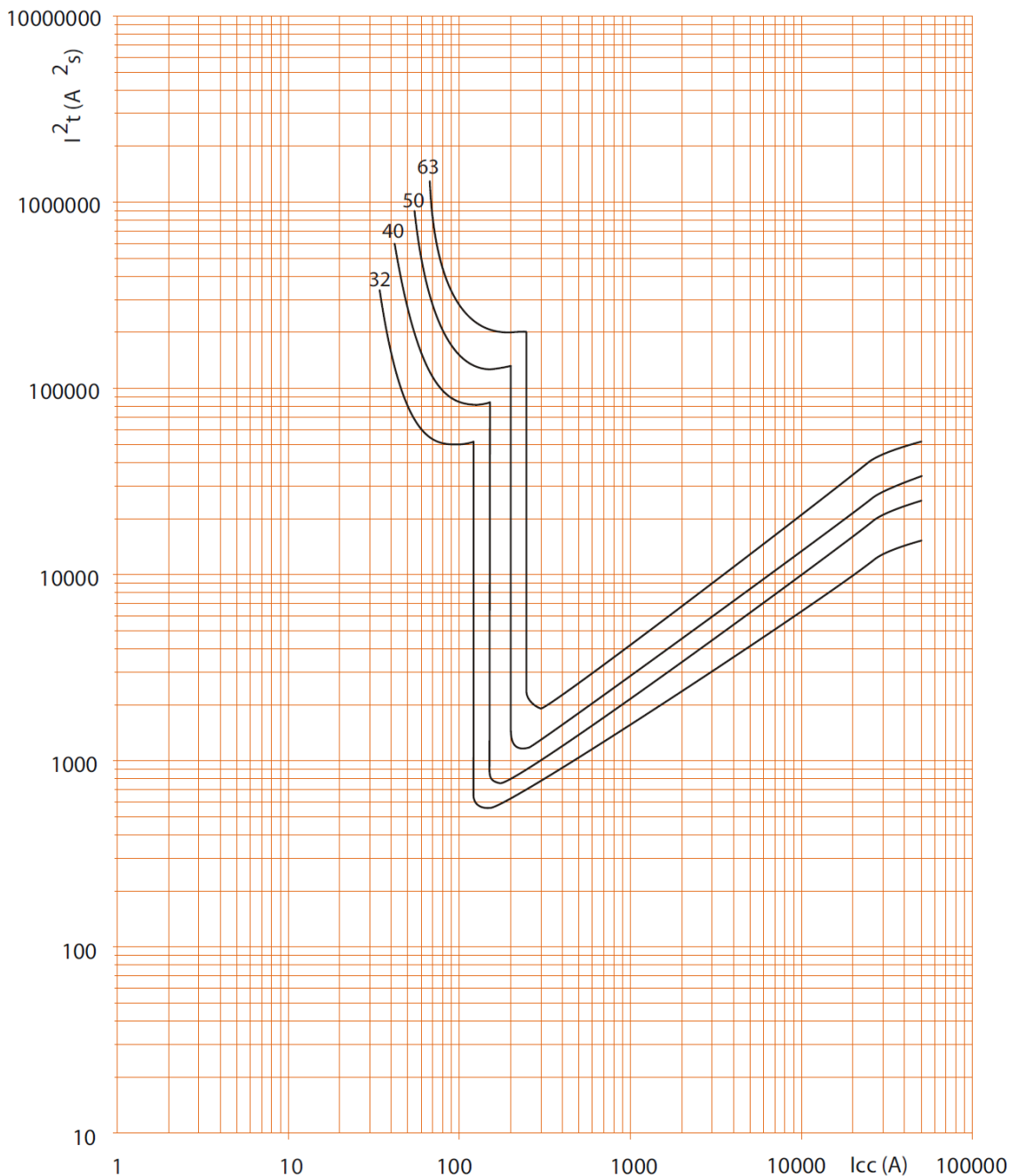

. Icc = Square value of symmetric component of the short circuit current (kA).
 . I²t = Thermal energy limited (A²s).

DX³ MCB 25kA up to 63A (1,5 modules per pole)

Cat N°(s): 4 097 20 to 4 098 95

7. CURVES *(continued)*

. Thermal energy limiting curves of circuit breakers B curve, 2P (400V~ / 50Hz) :

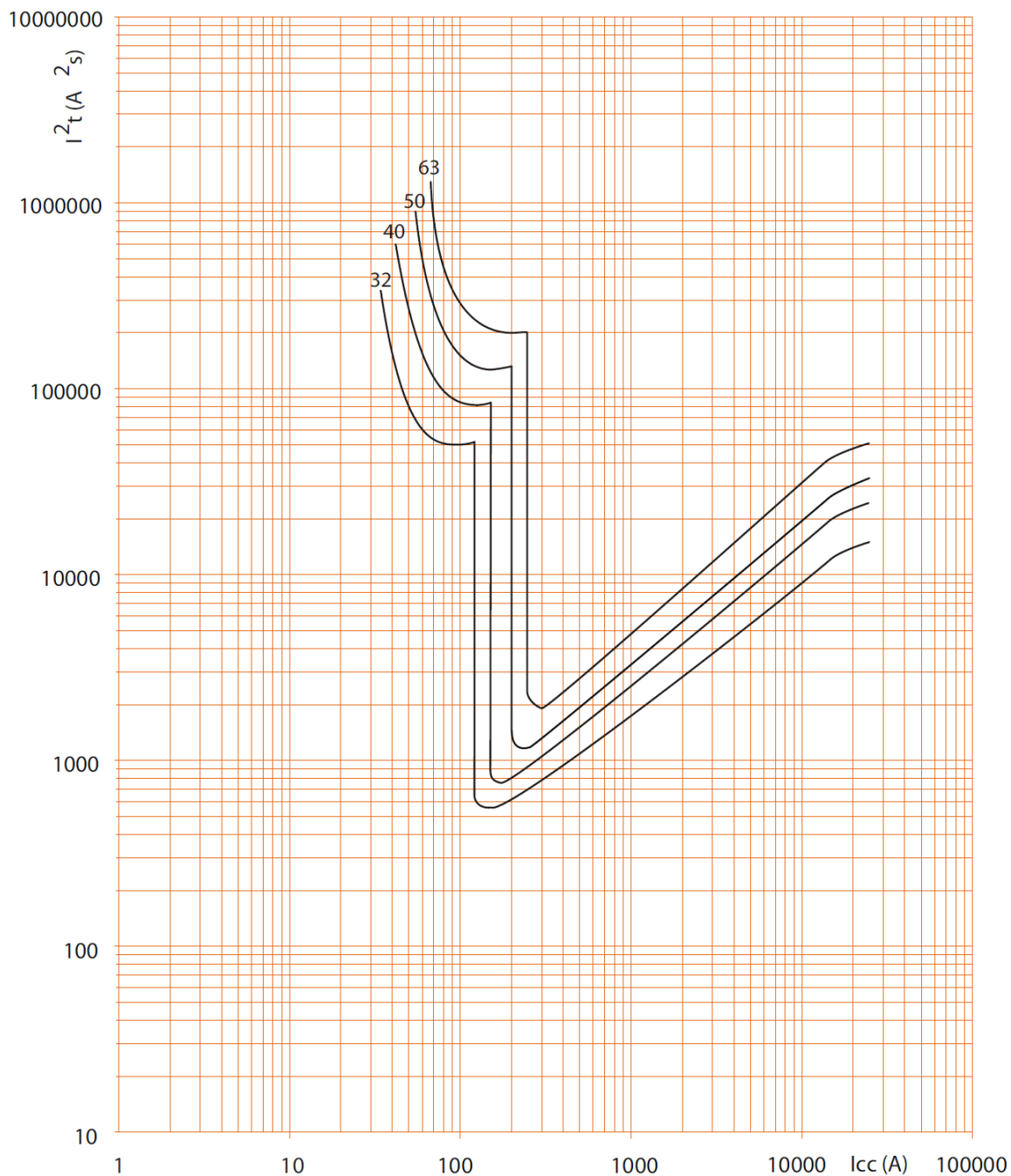

. I_{cc} = Square value of symmetric component of the short circuit current (kA).
 . I^2t = Thermal energy limited (A^2s).

DX³ MCB 25kA up to 63A (1,5 modules per pole)

Cat N°(s): 4 097 20 to 4 098 95

7. CURVES (continued)

. Thermal energy limiting curves of circuit breakers B curve, 3P / 4P (400V~ / 50Hz) :

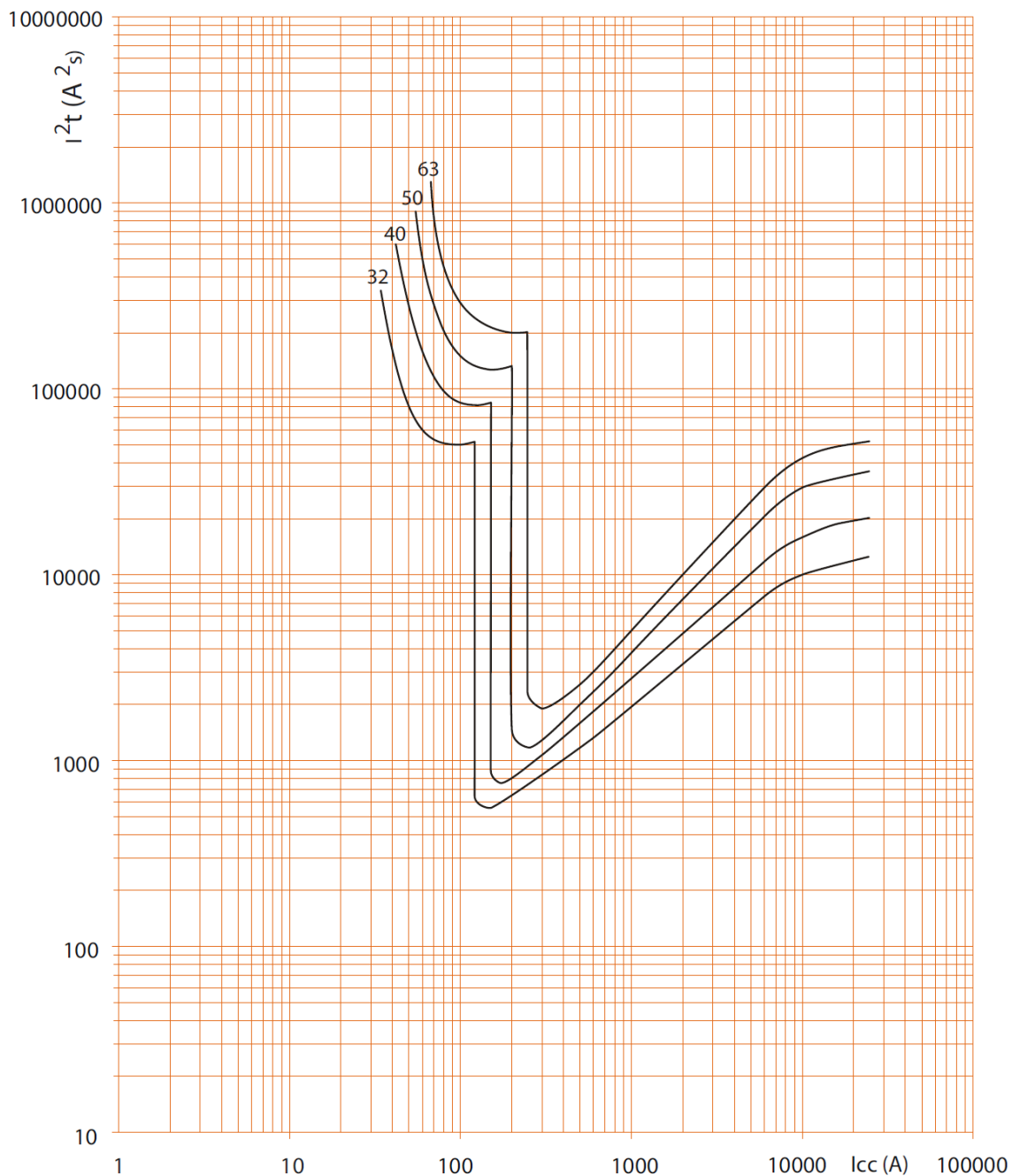

. I_{cc} = Square value of symmetric component of the short circuit current (kA).

. I^2t = Thermal energy limited (A²s).

7. CURVES *(continued)*

Operating characteristic of circuit breakers C curve:

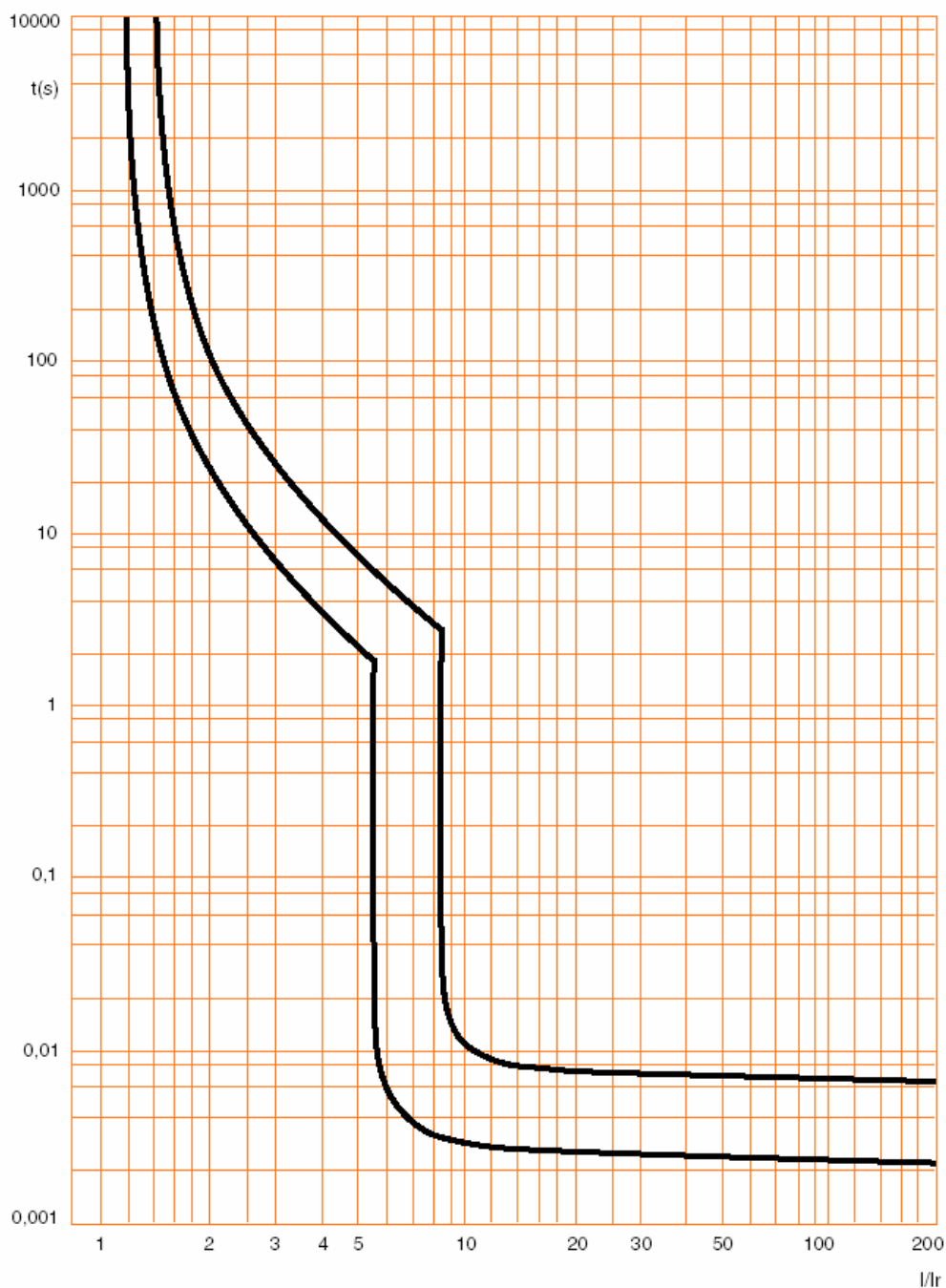

7. CURVES *(continued)*

. Thermal energy limiting curves of circuit breakers C curve , 2P (230V~ / 50Hz) :

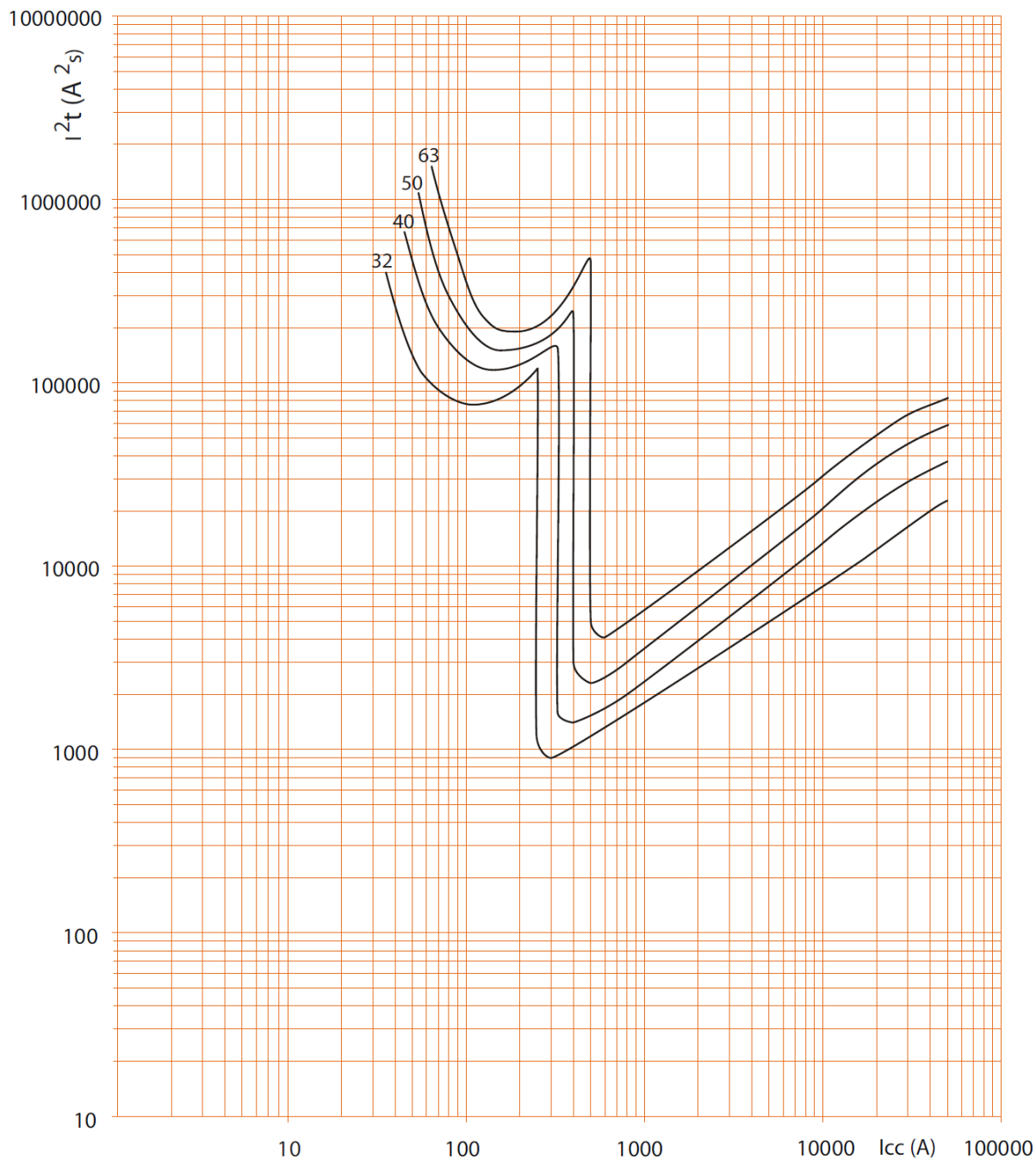

. I_{cc} = Square value of symmetric component of the short circuit current (kA).
 . I^2t = Thermal energy limited (A²s).

DX³ MCB 25kA up to 63A (1,5 modules per pole)

Cat N°(s): 4 097 20 to 4 098 95

7. CURVES *(continued)*

. Thermal energy limiting curves of circuit breakers C curve, 2P (400V~ / 50Hz) :

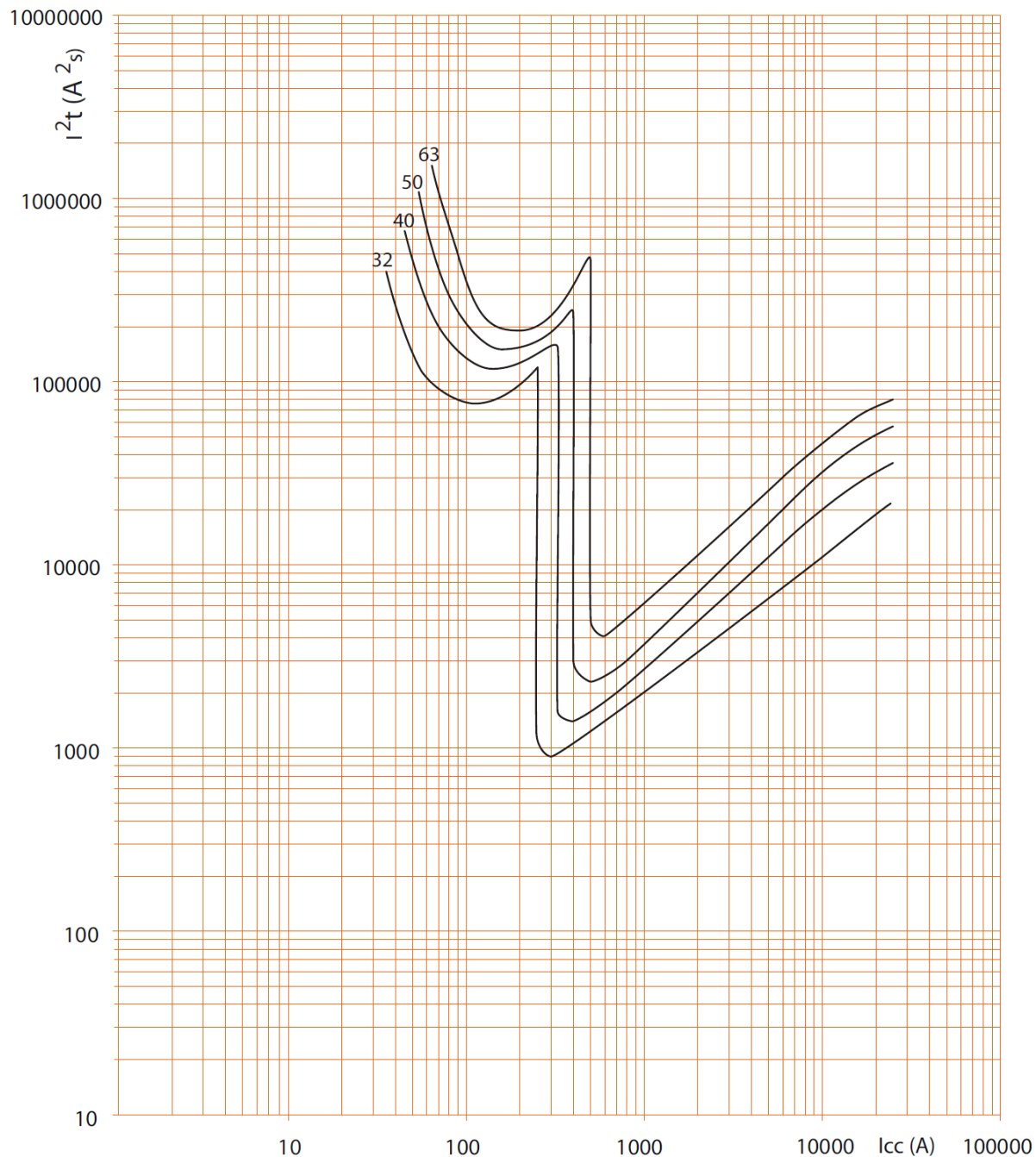

. I_{cc} = Square value of symmetric component of the short circuit current (kA).

. I^2t = Thermal energy limited (A^2s).

7. CURVES *(continued)*

. Thermal energy limiting curves of circuit breakers C curve, 1P / 3P / 4P (400V~ / 50Hz) :

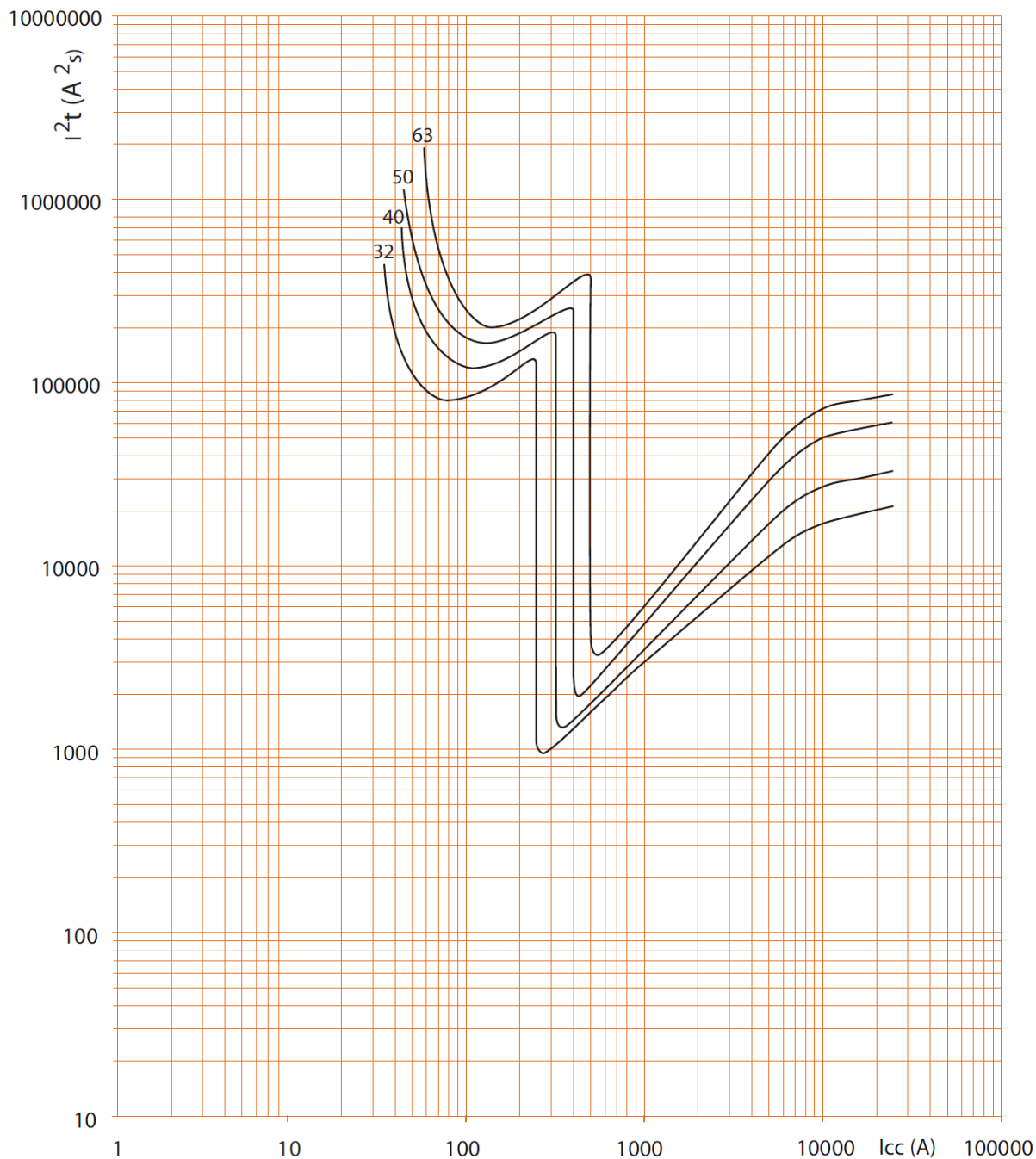

. I_{cc} = Square value of symmetric component of the short circuit current (kA).
 . I^2t = Thermal energy limited (A²s).

7. CURVES *(continued)*

Operating characteristic of circuit breakers D curve:

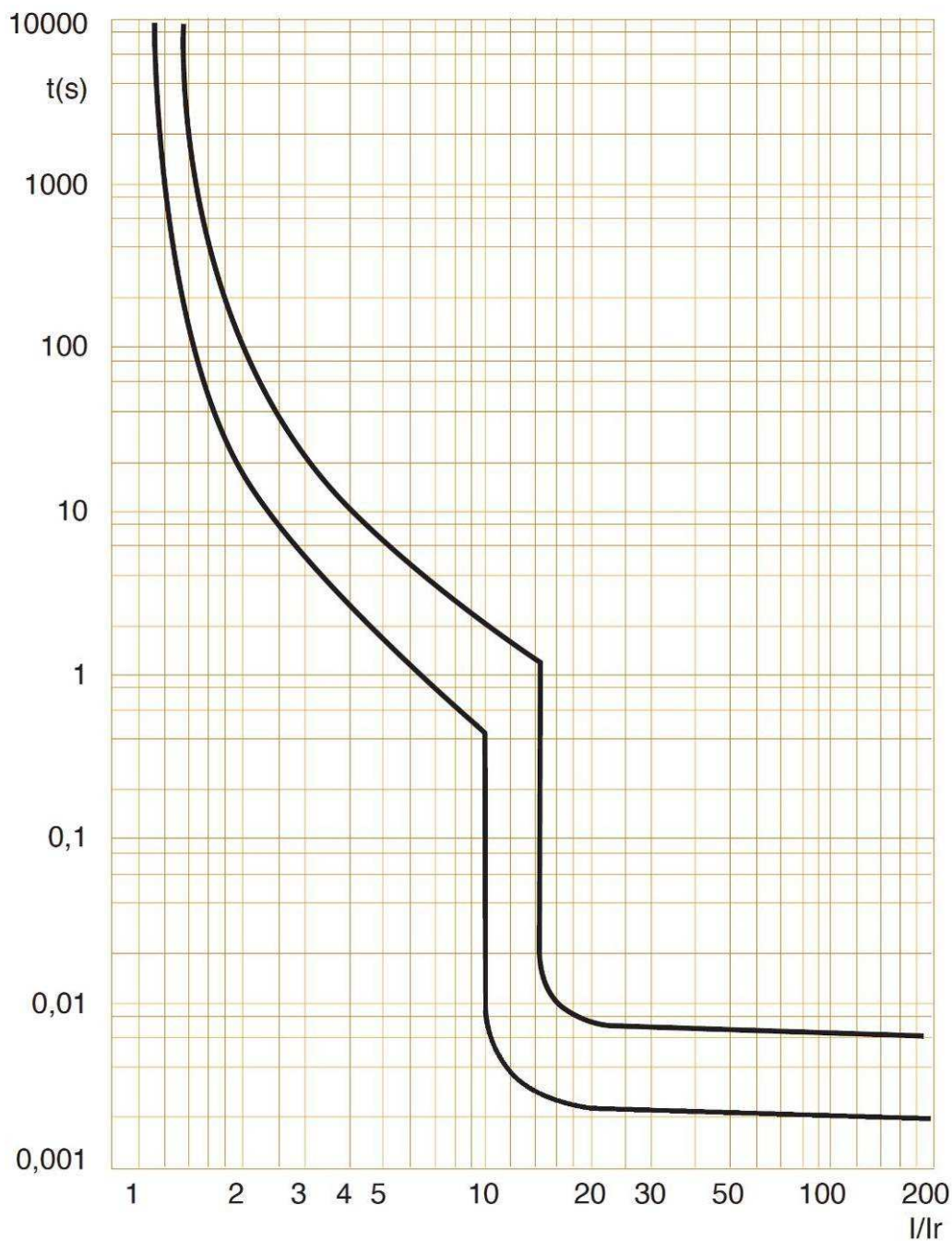

7. CURVES *(continued)*

. Thermal energy limiting curves of circuit breakers D curve, 2P (230V~ / 50Hz) :

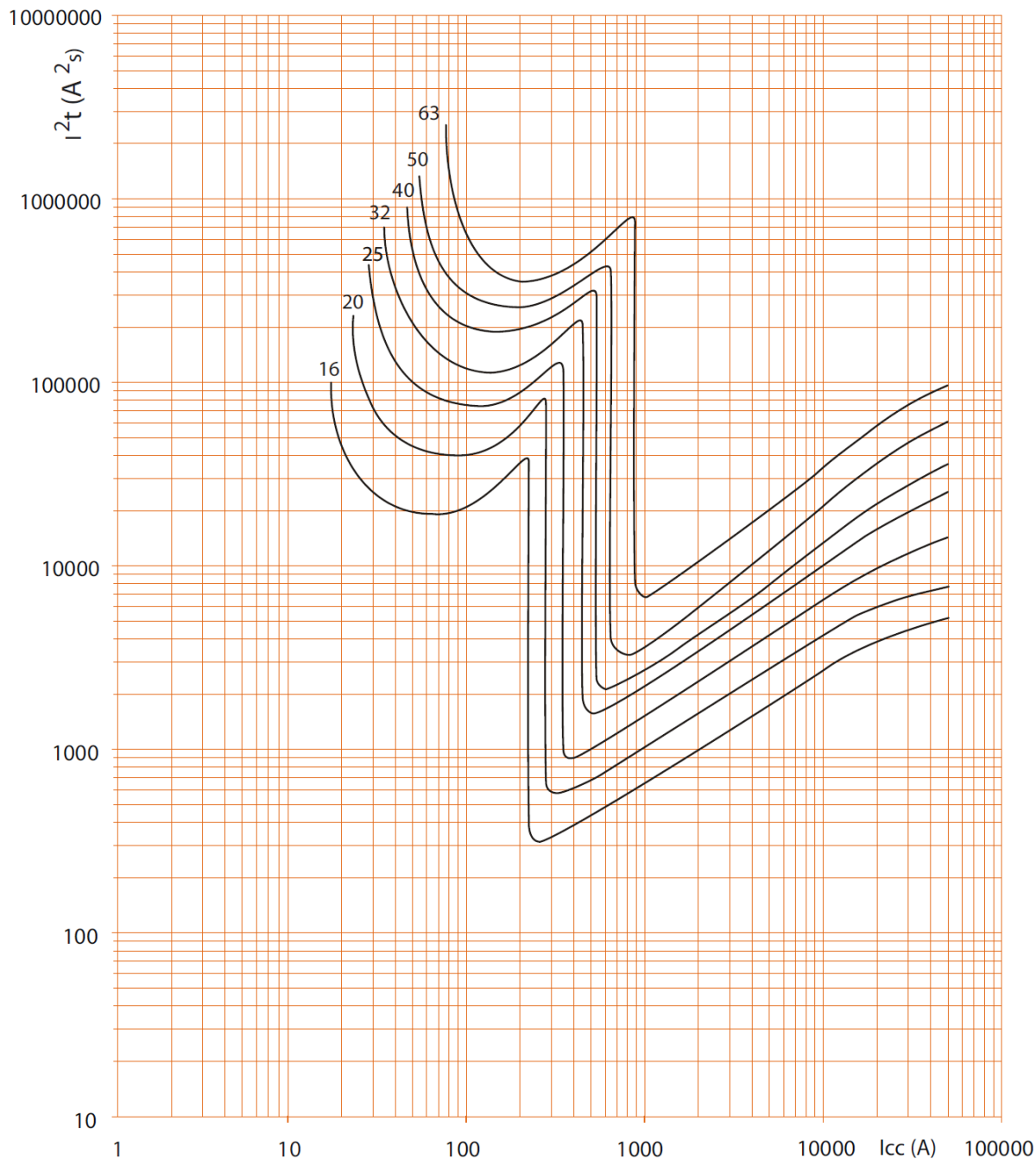

. I_{cc} = Square value of symmetric component of the short circuit current (kA).
 . I^2t = Thermal energy limited (A²s).

DX³ MCB 25kA up to 63A (1,5 modules per pole)

Cat N°(s): 4 097 20 to 4 098 95

7. CURVES *(continued)*

. Thermal energy limiting curves of circuit breakers D curve, 2P (400V~ / 50Hz) :

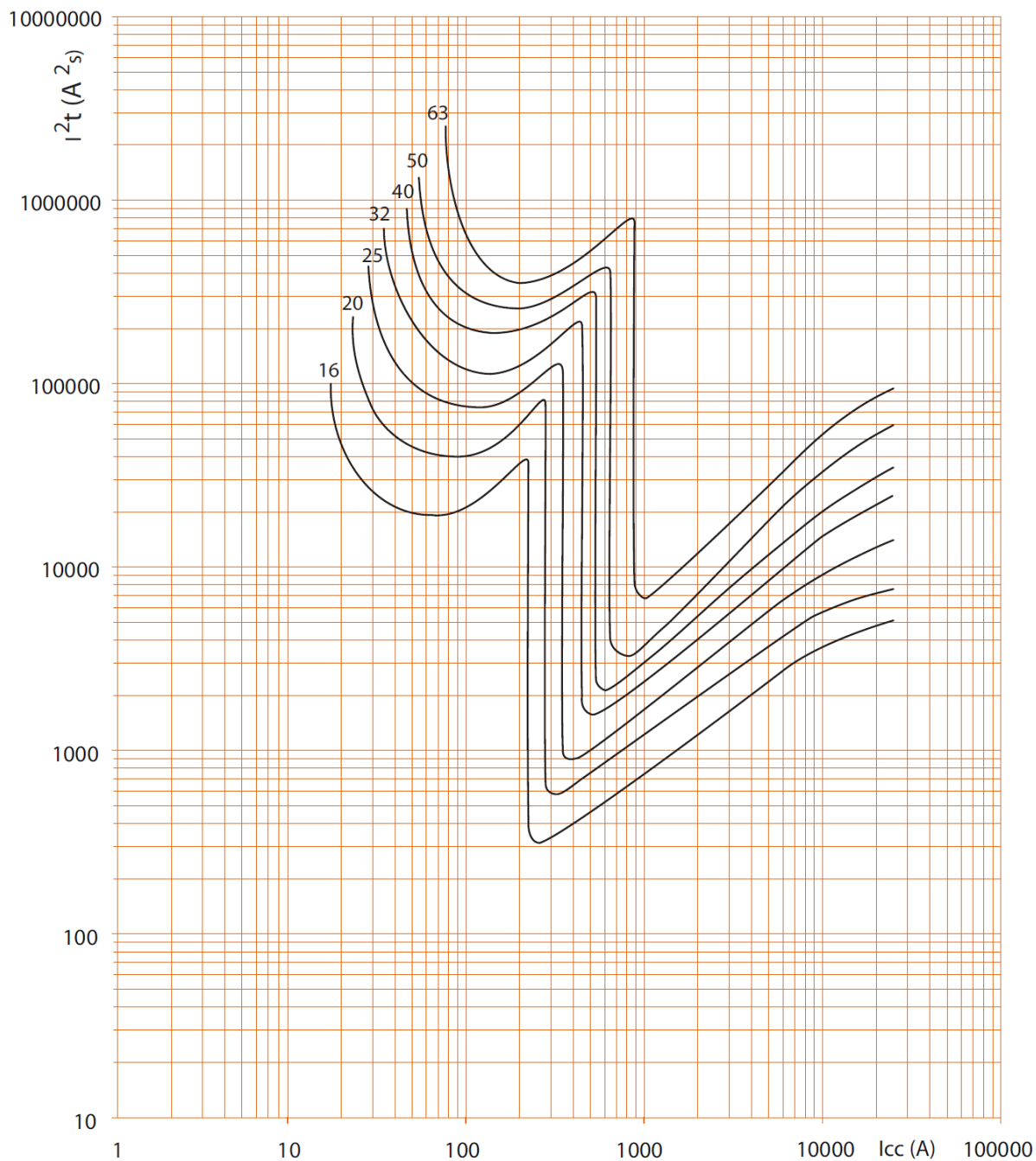

. I_{cc} = Square value of symmetric component of the short circuit current (kA).
 . I^2t = Thermal energy limited (A^2s).

7. CURVES *(continued)*

. Thermal energy limiting curves of circuit breakers D curve, 1P / 3P / 4P (400V~ / 50Hz) :

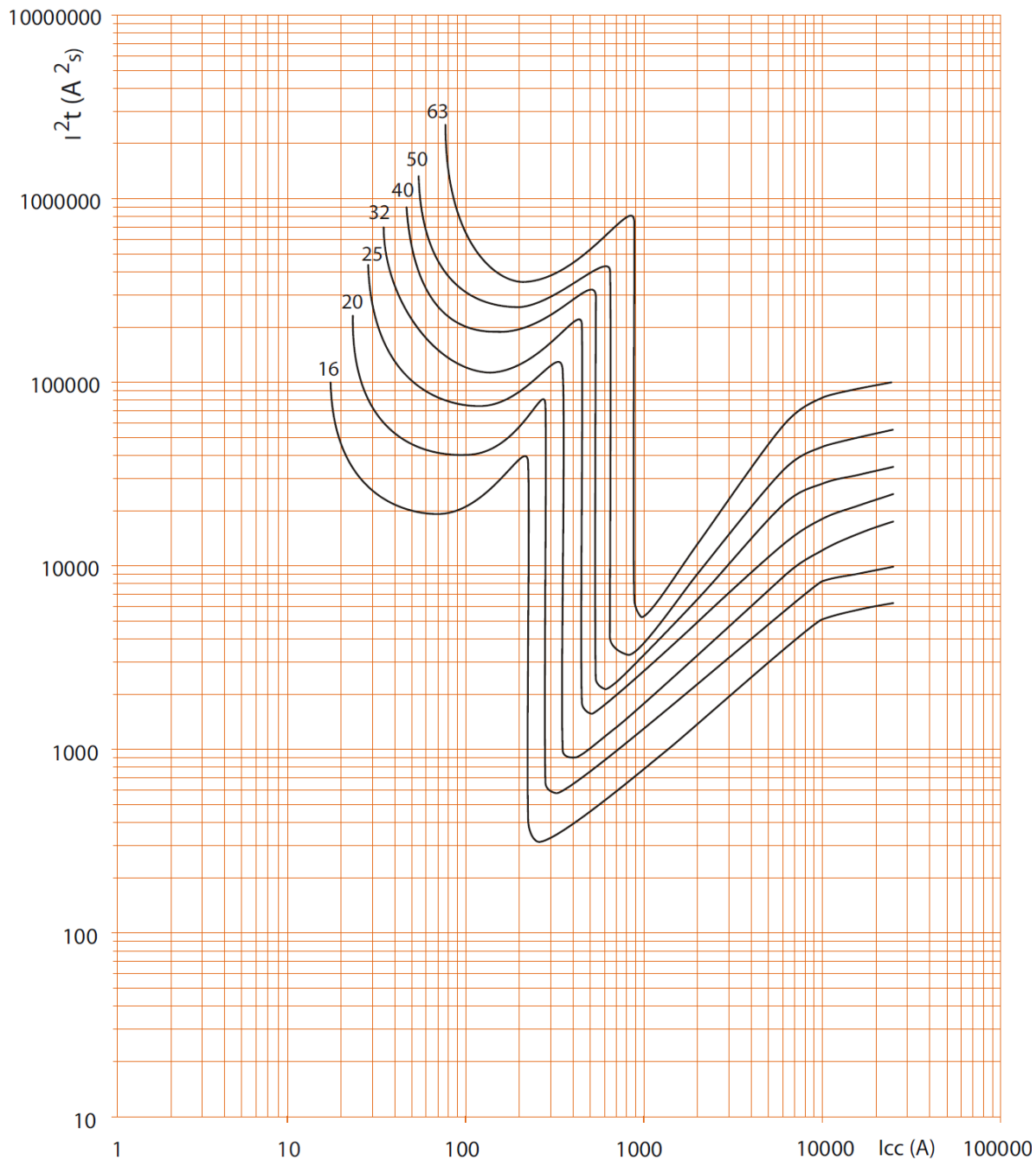

. Icc = Square value of symmetric component of the short circuit current (kA).
 . I²t = Thermal energy limited (A²s).

DX³ MCB 25kA up to 63A (1,5 modules per pole)

Cat N°(s): 4 097 20 to 4 098 95

7. CURVES *(continued)*

Operating characteristic of circuit breakers MA curve:

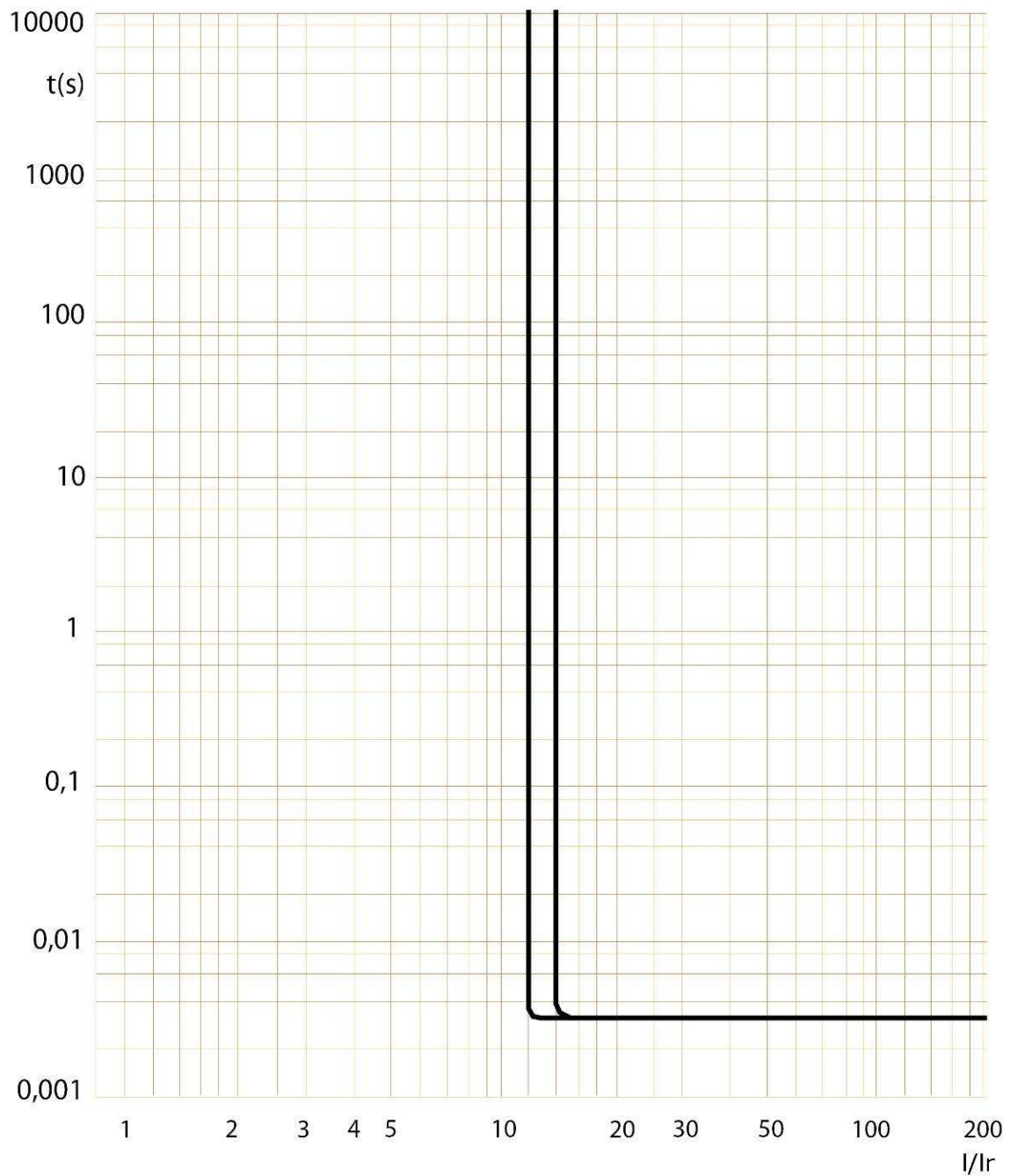

7. CURVES *(continued)*

. Thermal energy limiting curves of circuit breakers MA curve, 2P (230V~ / 50Hz) :

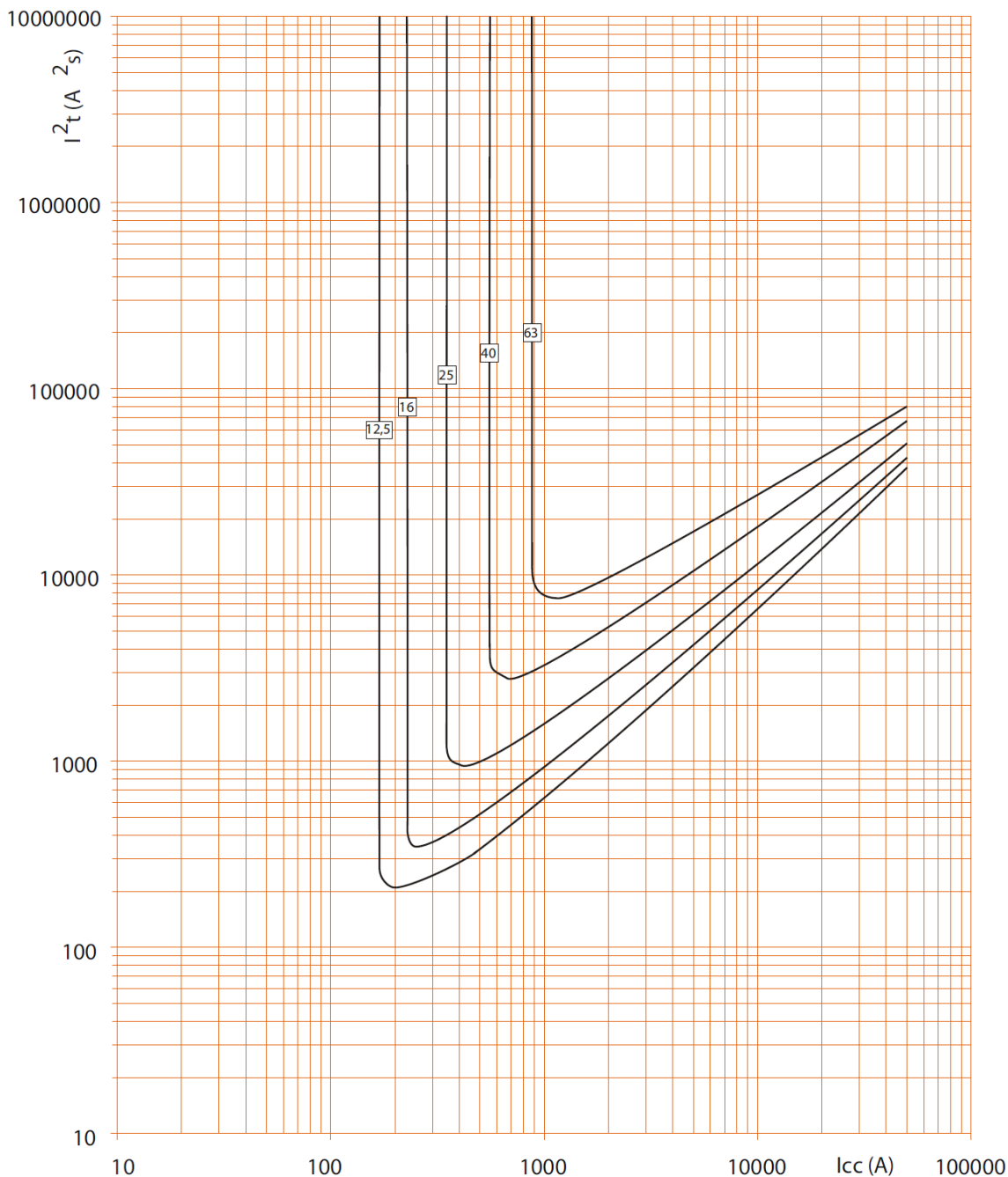

. Icc = Square value of symmetric component of the short circuit current (kA).
 . I²t = Thermal energy limited (A²s).

7. CURVES *(continued)*

. Thermal energy limiting curves of circuit breakers MA curve, 2P (400V~ / 50Hz) :

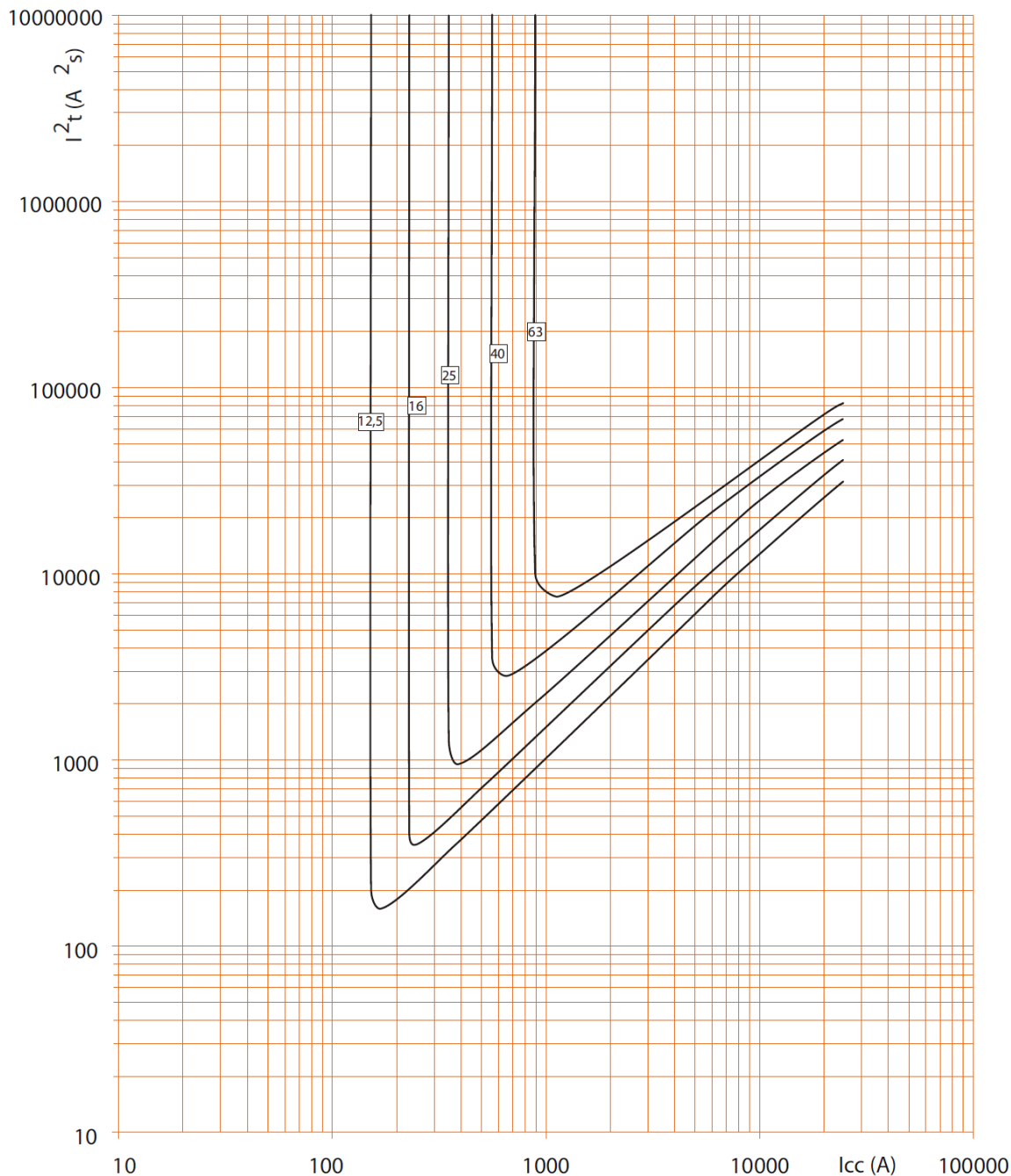

. I_{cc} = Square value of symmetric component of the short circuit current (kA).
 . I²t = Thermal energy limited (A²s).

7. CURVES (continued)

. Thermal energy limiting curves of circuit breakers MA curve, 3P / 4P (400V~ / 50Hz) :

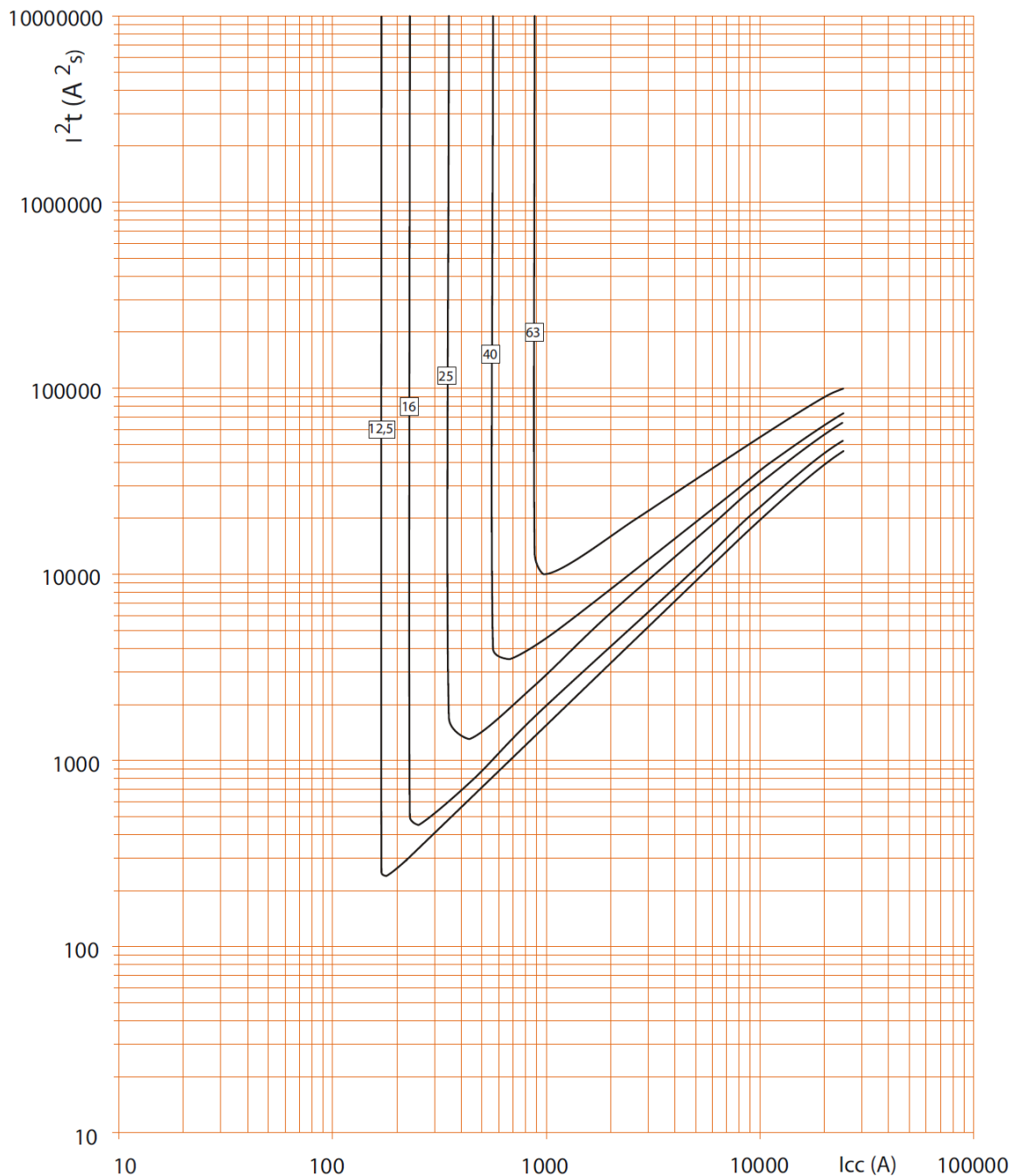

. I_{cc} = Square value of symmetric component of the short circuit current (kA).
 . I²t = Thermal energy limited (A²s).

DX³ MCB 25kA up to 63A (1,5 modules per pole)

Cat N°(s): 4 097 20 to 4 098 95

8. AUXILIARIES AND ACCESSORIES

Add-on modules 63A:

mcb	Add on module		
	2P	3P	4P
2P	X	-	-
3P	-	X	-
4P	-	-	X

Wiring accessories:

- . Sealable screw cover (cat n° 4 063 06).
- . Insulating shields (cat n° 4 063 12)
- . Aluminium terminals 50mm² max (cat. N° 4 063 10)

Signal auxiliaries:

- . Auxiliary contact (½ module – cat n° 4 062 58).
- . Fault signalling changeover switch (½ module – cat n° 4 062 60).
- . Auxiliary contact modifiable in default signal (½ module – cat n° 4 062 62).
- . Auxiliary contact + fault signalling switch - can be modified to 2 auxiliary contacts (1 module - cat n° 4 062 66).

Control auxiliaries:

- . Shunt releases (1 module - cat n° 4 062 76 / 78).
- . Under voltage release (1 module - cat n° 4 062 80 / 82).
- . Autonomous shunt trip for NC push-button (1 module - cat n° 4 062 87).

Possible combinations of auxiliaries and MCBs:

- . The auxiliaries are installed to the left of the MCBs
- . Maximum number of auxiliaries = 3.
- . Maximum number of 1 module signalling auxiliaries = 2.
- . Maximum number of control auxiliaries (Cat. N° 4 063 76 to 4 062 87) = 1.
- . The control auxiliary (Cat.N°. 4 062 76 to 4 062 87) must mandatorily be placed to the left of the signalling auxiliaries (Cat. N°. 4 062 58 to 4 052 66) where the auxiliaries from these 2 families are connected to the same MCB.

Sealing:

- . Possible in "Open" mode (OFF) or "Close" mode (ON).

Locking options:

- . By padlock (Cat.N°. 4 063 13 or 0 227 97), whit padlock support (Cat.N°. 4 063 03).

Installation software:

- . XL PRO³